

Índice

• **Motobombas e Geradores**

- Pág. 03 - 04 → Motobombas
- Pág. 05 → Geradores

• **Eletrobombas submersíveis**

- Pág. 06 → Eletrobombas Solares **Fluid Solar**
- Pág. 07 - 08 → **Alanol** com motor Franklin
- Pág. 09 → **Alanol** com motor **Coverco**
- Pág. 10 → **Alanol** Hidráulicos em aço inox
- Pág. 11 → Eletrobombas em **Aço Inox 304 – SP**
- Pág. 12 - 13 → Eletrobombas **E-TECH** by Franklin com motor **Coverco**
- Pág. 14 - 15 → Eletrobombas **E-TECH** by Franklin com motor **Franklin**
- Pág. 16 → Hidráulicos **E-TECH** by Franklin
- Pág. 17 → Eletrobombas, hidráulicos **IMPO** by Franklin, Cabos elétricos **Franklin** e condensadores
- Pág. 18 → **Alanol e Matra** para poço
- Pág. 19 → Motores submersíveis (**Franklin e Coverco**) Condensadores e cabos de motor **Franklin**
- Pág. 20 - 24 → **Drenagem - Fossas** (Diversas - águas sujas e limpas)
- Pág. 25 → **Ornamentais** (Lagos e iluminação)

• **Eletrobombas superfície**

- Pág. 26 - 28 → Eletrobombas **Matra** (Rega, Hidropneumáticas c/autoclave e pressostato electrónico)
- Pág. 29 - 30 → Eletrobombas **Leo** (Rega, Hidropneumáticas c/autoclave, pressostato electrónico)
- Pág. 31 → Eletrobombas **Campeon e Happy** (Rega, Hidropneumáticas c/autoclave)
- Pág. 32 → Eletrobombas **Oliju** (Rega, Hidropneumáticas c/autoclave)
- Pág. 33 - 34 → **Alanol** (Rega, Hidropneumáticas c/autoclave e pressostato electrónico)
- Pág. 35 → Eletrobombas **Trasfega**

• **Autoclaves, Pressostatos, Manómetros**

- Pág. 36 → **Zilmet** (Ferro) **Wellmate** (Fibra) **Alanol** (Aço inox 6 e 10 bars) Membranas diversas
- Pág. 37 → Autoclaves **Reflex e HS** (Eco)
- Pág. 38 → Pressostatos (**Mew, Square-D, Italtécnica**), controlador pressão, variador de velocidade, Manómetros, Tês 5 vias

• **Quadro elétricos**

- Pág. 39 - 41 → Quadros elétricos diversos
- Pág. 42 → Contatores térmicos, **Cabo elétrico** e Manga vulcanização
- Pág. 43 → Relés eletrónicos diversos

• **Artigos de piscina**

- Pág. 44 - 45 → Eletrobombas, Filtros e tubos piscina
- Pág. 46 → Skimmer, ralo de fundo, Boquilhas, projetor, escadas, duches e válvula seletora
- Pág. 47 → Mangueira flutuante, acessórios de limpeza, sal, areia para filtros e limpa fundos
- Pág. 48 → Aparelhos de sal e quadros de piscina
- Pág. 49 - 50 → Produtos químicos para tratamento da água da piscina (**Ecopool e CTX**)

• **Filtros Domésticos**

- Pág. 51 → Filtros domésticos

• **Bombas doseadoras**

- Pág. 52 → Dosificadores e Depósitos

• **Rega agrícola**

- Pág. 53 → Filtros de gravilha, hidrociclones, fertilizadores e contadores de água
- Pág. 54 → Filtros de rega, lamelas e **Acqua Bridge**
- Pág. 55 - 57 → **Marlux** (aspersores e acessórios de rega diversos)
- Pág. 58 → **V.D.** (Acessórios zincados diversos)
- Pág. 59 → **Metal-Pi** (Canhões de rega de longo alcance e Tripés)
- Pág. 60 - 63 → Aspersão e micro-regas para rega localizada
- Pág. 64 → Tubo gotejador, fita gotejadora e microjets com acessórios diversos de ligação
- Pág. 65 → **Válvulas hidráulicas**, solenoides, pilotos e acessórios

• **Rega de espaços verdes**

- Pág. 66 - 70 → Eletroválvulas, programadores, sensores meteorológicos aspersores de jardim e acessórios
- Pág. 71 - 79 → **SAB** (Mini-válvulas, artigos fita e manga, acessórios de ligação rápido e válvulas em polítileno)

• **Material de canalização**

- Pág. 80 - 84 → **Plimat** (Válvulas, acessórios de PVC – roscados, colagem e transição)
- Pág. 85 - 89 → **PPR**, Válvulas de esfera, Junções **Swift**, chupadores, abraçadeiras, acessórios latão, tubos flexíveis e tampas de furo
- Pág. 90 → Válvulas de esfera metálicas
- Pág. 91 → Válvulas retenção em latão e inox
- Pág. 92 → Acessórios **GEKA**
- Pág. 93 → Abraçadeiras
- Pág. 94 - 97 → Acessórios em latão
- Pág. 98 → Acessórios em **INOX AISI 316**
- Pág. 99 - 100 → Acessórios diversos

• **Tubos diversos**

- Pág. 101 - 106 → Polietileno de baixa e alta densidade, tubos jardim, tubo PVC, Hidronil, Galvanizado e tubo sucção e Tubo Hidroroscado

• **Válvulas de fundição**

- Pág. 107 - 108 → Válvulas retenção, filtros, juntas e flanges

• **Depósitos para água potável e Etar's**

- Pág. 109 - 110 → Depósitos e Etar's em polietileno diversos (Depósitos de 100 Lts a 35000 Lts)

• **Diversos**

- Pág. 111 → Acessórios para bombas diversos

Condições gerais de venda

- a) → As mercadorias viajam por conta e risco do cliente.
- b) → Só aceitamos devoluções, até 8 dias da data da factura e de acordo mútuo.
- c) → ***Motores queimados não têm garantia dos fabricantes.***
- d) → Pagamentos a 30 dias, deverão ser efectuados, líquidos e de acordo com as condições estabelecidas. Caso estas não sejam regularizadas dentro dos prazos estabelecidos serão debitados juros de mora à taxa em vigor.
- e) → **3%** desconto pronto pagamento, até **15 dias** da data da factura.
- f) → As vendas a crédito, serão efectuadas apenas sobre valores superiores a 50,00 €.
- g) → A Hidrosado, Lda., reserva – se o direito de, em qualquer momento cancelar os fornecimentos, nomeadamente nos casos em que os limites de crédito, valor ou prazo sejam ultrapassados.
- h) → O limite de crédito é estabelecido unicamente pela Hidrosado, sem que esta tenha de o justificar.
- i) → Em caso de litígio, o foro competente será sempre o da Comarca de Setúbal.
- j) → Pagamentos por transferência bancaria **IBAN n.º** PT50 003300000788024992523
- k) → A mercadoria só é propriedade do cliente após boa cobrança da mesma.
- l) → A Hidrosado, Lda., reserva-se do direito de não se responsabilizar do despacho de mercadorias pelas transportadoras após no acto da recepção o cliente não verificar se a mercadoria está danificada.



Hidrosado, Lda.
 Quinta Varzinha, Lote 25
 2900-721 Setúbal
 Telefone: 265537550
 Fax: 265537551
 Mail: geral@hidrosado.pt
 Site: www.hidrosado.pt

Motobombas



Motobomba LGP 10 - Gasolina mistura

Óleo não incluído

Características Técnicas:

Modelo	Prof. Asp. (mts)	Pressão (Bar)	Tipo Motor (T)	Cilindr. (CC)	RPM (máx.)	Sist. Arref.	Sist. Arranq.	Cap. Depósito	Dimen. (mm)	Peso (Kg)
LGP10	8	3,5	2	42,7	7500	Ar	Manual	1L	350x290x325	8
LGP15	8	3,5	2	42,7	7500	Ar	Manual	1L	355x210x370	9

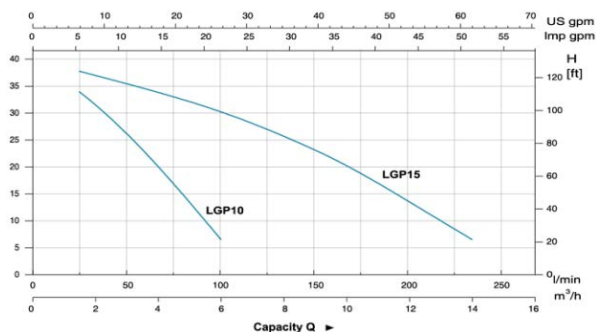

Código	Modelo	Ø	HP	Capacity Q													Preço		
				m ³ /h	0,0	2,0	4,0	6,0	8,0	10,0	12,0	14,0	16,0						
01,1000	LGP 10	1"	1,6	L/mim	0,0	33,3	66,7	100,0	133,3	166,7	200,0	233,3	-	-	-	-	-	-	235,00 €
01,1001	LGP 15	1.½"	1,6	H (m)	40,2	32,1	20,4	6,5	-	-	-	-	-	-	-	-	-	-	245,00 €

Óleo não incluído

Características Técnicas:

Modelo	Prof. Asp. (mts)	Pressão (Bar)	Tipo Motor (T)	Cilindr. (CC)	RPM (máx.)	Sist. Arref.	Sist. Arranq.	Cap. Depósito	Dimen. (mm)	Peso (Kg)
LGP20-A	8	3	4	163	3600	Ar	Manual	2,8L	470x412x432	21,5
LGP30-A	8	3	4	196	3600	Ar	Manual	2,8L	470x412x432	22,5

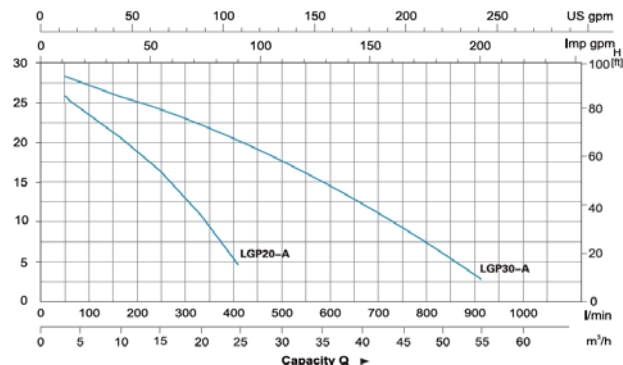

Motobomba LGP 20-A - Gasolina S/Chumbo e Gasóleo

Código	Modelo	Ø	HP	Capacity Q													Preço			
				m ³ /h	0,0	5,0	10,0	15,0	20,0	25,0	30,0	35,0	40,0	45,0	50,0	55,0		60,0		
01,1002	LGP 20-A	2"	5,5	L/mim	0,0	83,3	166,7	250,0	333,3	416,7	500,0	583,3	666,7	750,0	833,3	916,7	1000,0	-	-	362,00 €
01,1003	LGP 30-A	3"	6,5	H (m)	28,6	25,1	21,6	17,6	13,4	5,9	-	-	-	-	-	-	-	-	404,00 €	
01,1006	LDP 30-A	3"	5,4		18	17	16,5	15,5	14	12	10	8	6,4	4,4	-	-	-	-	927,00 €	

Óleo não incluído

Características Técnicas:

Modelo	Prof. Asp. (mts)	Pressão (Bar)	Tipo Motor (T)	Cilindr. (CC)	RPM (máx.)	Sist. Arref.	Sist. Arranq.	Cap. Depósito	Dimen. (mm)	Peso (Kg)
LGP20-H	6	5,5	4	196	3600	Ar	Manual	2,8L	463x398x406	22,2
LGP20-2H	6	8	4	196	3600	Ar	Manual	2,8L	463x398x406	22,2

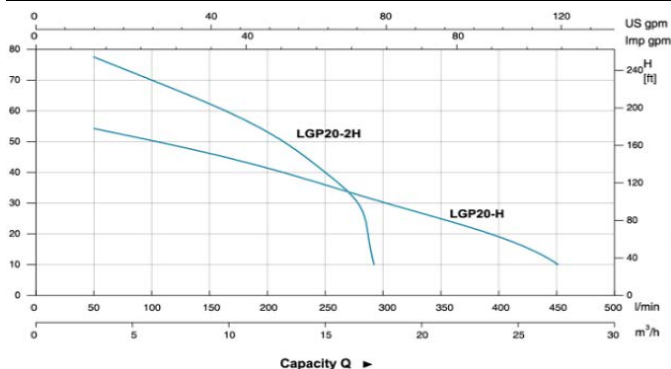

Motobomba LGP 20-H - Gasolina S/Chumbo

Código	Modelo	Ø	HP	Capacity Q													Preço		
				m ³ /h	0,0	5,0	10,0	15,0	20,0	25,0									
01,1004	LGP 20-H	2"x1.½"	6,5	L/mim	0,0	83,3	166,7	250,0	333,3	416,7									422,00 €
01,1005	LGP 20-2H	2"x1.½"	6,5	H (m)	58	52	44,3	36	27	17									415,00 €

Nota: Esta tabela pode ser alterada sem aviso prévio, preços sujeitos à taxa de I.v.a. em vigor.
 Setúbal, 01 de Janeiro de 2018.



Hidrosado, Lda.
 Quinta Varzinha, Lote 25
 2900-721 Setúbal
 Telefone: 265537550
 Fax: 265537551
 Mail: geral@hidrosado.pt
 Site: www.hidrosado.pt

Motobombas

Campeón

Grupos Motobombas

Óleo não incluído

Motobomba Gasolina 2 tempos - Auto-Ferrante

Código	Modelo	Ø	HP	H(m)	5	10	12,5	15	17,5					Preço
01,1010	Xpump 25	1"	0,95	L/h	7.000	5.500	4.800	3.300	1.000					283,00 €



Óleo não incluído

Motobomba Gasolina 4 tempos - Auto-Ferrante

Código	Modelo	Ø	HP	H(m)	5	10	15	20	25	30				Preço
01,1011	MRX - 40	1.½"	2,50	L/h	10.000	6.000	1.000							361,00 €
01,1012	MRX - 50	2"	6,50		32.000	27.000	22.000	15.000						424,00 €
01,1013	MRX - 80	3"	6,50		53.000	46.000	37.000	24.000	2.000					487,00 €



Óleo não incluído

Motobomba Gasolina 4 tempos - Auto-Ferrante e contra-incêndios

Código	Modelo	Ø	HP	H(m)	5	10	15	20	25	30	35	40	50	Preço
01,1014	MRV - 50	3"	6,50		30.000	28.000	27.000	26.000	25.000	24.000	20.000	14.000	3.000	573,00 €



Óleo não incluído

Motobomba Gasolina 4 tempos - Águas sujas, marinas e fertilizantes Agrícolas

Código	Modelo	Ø	HP	H(m)	5	10	15	20	25	30	35	40	50	Preço
01,1015	MRQ - 50	2"	6,50	L/h	30.000	27.000	22.000	20.000	15.000	9.000				644,00 €
01,1016	MRW - 80	3"	6,50		45.000	30.000	16.000	12.000	3.000					1.164,00 €



Nota: Serviço técnico garantido pela própria marca

Nota: Esta tabela pode ser alterada sem aviso prévio, preços sujeitos à taxa de I.v.a. em vigor.
 Setúbal, 01 de Janeiro de 2018.



Hidrosado, Lda.
 Quinta Varzinha, Lote 25
 2900-721 Setúbal
 Telefone: 265537550
 Fax: 265537551
 Mail: geral@hidrosado.pt
 Site: www.hidrosado.pt

Geradores

Grupos Geradores



Óleo não incluído

Grupo Gerador Inverter



Código	Modelo	Volts	KVA	kW	Arranque	Depósito	Ligação corrente	Kg	Preço
01,4060	TG 1000i	230V	0,9 - 1,0	1,3	Manual	2,7 Lts	1 ligação	15	751,30 €



Óleo não incluído

Grupo Gerador de Energia



Código	Modelo	Volts	KVA	HP	Arranque	Depósito	Ligação corrente	Kg	Preço
01,4061	MK 5500	230V	4 - 4,5	11	Manual	25 Lts	2 Tomadas	80	1.132,75 €
01,4062	MK 6500	230V	5 - 5,5	13	Manual	25 Lts	2 Tomadas	82	1.265,60 €
01,4063	MK 6500T	400V	7 - 7,5	13	Manual	25 Lts	1 Tomada	86	1.412,75 €
01,4064	CT 6500A	230V	5 - 5,5	11	Eléctrico	25 Lts	3 Tomadas	79	1.535,60 €
01,4065	CT 8000A	230V	6 - 6,5	89	Eléctrico	25 Lts	3 Tomadas	89	1.714,15 €



Óleo não incluído

Grupo Gerador de Energia - Motor KOHLER



Código	Modelo	Volts	KVA	HP	Arranque	Depósito	Ligação corrente	Kg	Preço
01,4066	GK 6500ME	230V	6,8 - 7,5	14	Eléctrico	7,7 Lts	2 Tomadas	85	1.898,45 €



Óleo não incluído

Grupo Gerador de Energia - Motor Honda AVR - Regulação automática de tensão



Código	Modelo	Volts	KVA	HP	Arranque	Depósito	Ligação corrente	Kg	Preço
01,4067	GH 5000ME	230V	4 - 4,5	9	Eléctrico	6 Lts	2 Tomadas	68	2.157,00 €
01,4068	GH 5000ME AVR	230V	4 - 4,5	9	Eléctrico	6 Lts	2 Tomadas	69	2.457,00 €
01,4069	GH 6500ME	230V	6,8 - 7,5	13	Eléctrico	6,5 Lts	2 Tomadas	82	1.999,85 €
01,4070	GH 6500ME AVR	230V	6,8 - 7,5	13	Eléctrico	6,5 Lts	2 Tomadas	82	2.299,85 €
01,4071	GH 7000 TE	400V	5,5 - 6,0	9	Eléctrico	6 Lts	1 Tomada	68	2.521,30 €

Nota: Serviço técnico garantido pela própria marca

Nota: Esta tabela pode ser alterada sem aviso prévio, preços sujeitos à taxa de I.v.a. em vigor.
 Setúbal, 01 de Janeiro de 2018.



Hidrosado, Lda.
 Quinta Varzinha, Lote 25
 2900-721 Setúbal
 Telefone: 265537550
 Fax: 265537551
 Mail: geral@hidrosado.pt
 Site: www.hidrosado.pt

Eletrobombas Solares



KITS ELECTROBOMBAS SUBMERSÍVEIS SOLARES 4"

Características Técnicas:

Temperatura máxima do Fluido: +35°C • Permitem a passagem de areia até 150g por m³ • Painéis fotovoltaicos de alta eficiência Motor de alto desempenho com inversor incorporado.

Instalação e Uso:

A bomba Fluid Solar é utilizada no bombeamento de águas limpas utilizando a energia do sol fornecida pelos painéis solares. O inversor incorporado no motor converte a tensão de saída a partir dos painéis e controla a velocidade de rotação do motor, de modo a maximizar a energia fornecida pelos painéis.

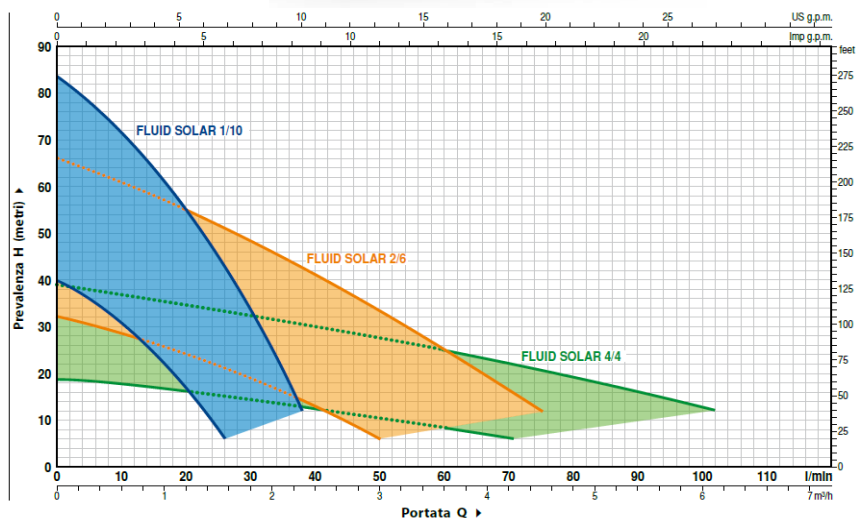
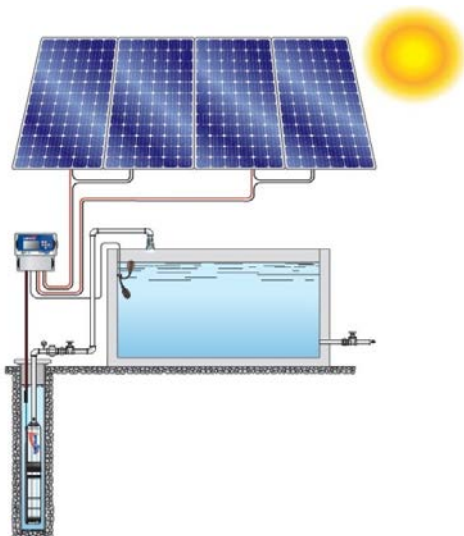

Constituição do Kit: Bomba submersível solar multicelular com 2 mts. cabo • Inversor incorporado no motor Quadro de controlo com proteção de falta de água no furo (permite incorporar 1 interruptor de boia p/ control de nível no reservatório) • Kit Termoretrátil p/ ligação dos cabos • 4 Painéis de 250W • Estrutura Fixação Plana (2 strings de 2 módulos) • 5 Fichas fêmea • 5 Fichas Macho.

KITS (Inclui todos os equipamentos descritos na constituição do Kit)

Código	Mod.	Kw	Ø	m3/h L/mim	0,0	0,3	0,6	1,2	1,6	1,8	2,3	3,0	3,6	4,3	4,5	4,8	5,7	6,1	Preço	
					0,0	5	10	20	26	30	38	50	60	71	75	80	95	102		
05,7095	Fluid Solar 1/10 Kit 730	750 W	1"	H (m)	84	79	72	56	42	33	12									4.443,00 €
					40	36	31	17	6											
05,7096	Fluid Solar 2/6 Kit 731	750 W	1"	H (m)	66	64	61	55	51	48	43	33	25	15	12					4.368,00 €
					32	31	28	24	21	19	14	6								
05,7097	Fluid Solar 4/4 Kit 732	750 W	1"	H (m)	39	39	37	35	33,5	32,5	31	27	25	22	21	18	14	12		4.368,00 €
					19	18,5	17,5	16	15	14	13	10	8	6						

→ Performances com painéis fotovoltaicos com uma tensão de circuito aberto de 100VDC e uma radiação solar de 1000W/m2.

→ Performances com painéis fotovoltaicos com uma tensão de circuito aberto de 70VDC e uma radiação solar de 300W/m2.

Nota: Esta tabela pode ser alterada sem aviso prévio, preços sujeitos à taxa de I.v.a. em vigor.
 Setúbal, 01 de Janeiro de 2018.



Hidrosado, Lda.

Quinta Varzinha, Lote 25

2900-721 Setúbal

Telefone: 265537550

Fax: 265537551

Mail: geral@hidrosado.pt

Site: www.hidrosado.pt



C / Motor  **Franklin Electric**

Código	Mod.	HP	Ø	m3/h L/mim	0.3	0.6	0.9	1.2	1.5	1.8	2.1	2.4	2.7	3.0	3.3	3.6	Volts	Preço	
					5	10	15	20	25	30	35	40	45	50	55	60			
05,7000	14 C	0,50	1.¼"	Altura Manométrica	72	67	59	50	41	31	21	14					230	438,67 €	
05,7005																	400	433,16 €	
05,7001	17 C	0,75			85	81	73	67	58	45	32	22						230	475,50 €
05,7006																		400	459,48 €
05,7042	21 C	0,75			101	94	86	77	67	52	37	26						230	494,69 €
05,7044																		400	478,67 €
05,7002	28 C	1,00			139	132	119	103	87	68	47	33						230	553,36 €
05,7007																		400	533,36 €
05,7003	35 C	1,50			175	166	150	132	113	88	66	40						230	645,51 €
05,7008																		400	624,00 €
05,7004	42 C	2,00			210	200	182	163	140	112	83	48						230	766,83 €
05,7009																		400	709,59 €
05,7043	50 C	2,00			243	229	208	185	160	128	95	58						230	811,12 €
05,7045																		400	753,77 €

Código	Mod.	HP	Ø	m3/h L/mim	0.3	0.6	0.9	1.2	1.5	1.8	2.1	2.4	2.7	3.0	3.3	3.6	Volts	Preço	
					5	10	15	20	25	30	35	40	45	50	55	60			
05,7010	10 D	0,50	1.¼"	Altura Manométrica	53	52	51	50	47	43	39	33	28	20	13	5	230	417,55 €	
05,7015																	400	417,35 €	
05,7011	14 D	0,75			76	74	72	70	64	60	52	45	37	28	17	6		230	457,65 €
05,7016																		400	441,73 €
05,7012	18 D	1,00			99	95	92	89	84	79	70	60	49	37	21	7		230	501,84 €
05,7017																		400	481,84 €
05,7013	25 D	1,50			139	135	131	128	120	110	99	87	70	52	32	9		230	584,59 €
05,7018																		400	559,89 €
05,7014	34 D	2,00			186	182	176	169	158	147	132	115	94	70	42	11		230	730,00 €
05,7019																		400	671,33 €
05,7020	47 D	3,00			257	252	243	232	220	203	183	160	141	100	60	15		400	823,16 €
05,7046	60 D	4,00			330	321	310	296	279	259	234	205	173	131	81	18		400	1.137,76 €

Código	Mod.	HP	Ø	m3/h L/mim	0.6	1.2	1.8	2.4	3.0	3.6	4.2	4.8	5.4	6.0	6.6	Volts	Preço		
					10	20	30	40	50	60	70	80	90	100	110				
05,7021	7 E	0,75	1.¼"	Altura Manométrica	46	45	42	40	37	33	29	25	20	14	7	230	426,33 €		
05,7025																400	410,40 €		
05,7022	10 E	1,00			62	59	57	52	49	44	38	32	25	18	10			230	468,27 €
05,7026																		400	448,57 €
05,7023	15 E	1,50			96	93	89	84	78	70	60	50	38	25	13			230	548,26 €
05,7027																		400	523,57 €
05,7024	20 E	2,00			129	125	122	113	104	92	79	66	50	32	15			230	678,57 €
05,7028																		400	625,30 €
05,7029	32 E	3,00			197	187	175	162	148	131	113	93	71	48	25			400	798,67 €
05,7030	39 E	4,00			239	228	216	202	185	167	147	123	98	68	35			400	1.086,63 €
05,7053	48 E	5,50			288	276	261	245	227	205	182	154	125	90	50			400	1.288,87 €



Nota: Esta tabela pode ser alterada sem aviso prévio, preços sujeitos à taxa de I.v.a. em vigor.

Setúbal, 01 de Janeiro de 2018.



Hidrosado, Lda.
 Quinta Varzinha, Lote 25
 2900-721 Setúbal
 Telefone: 265537550
 Fax: 265537551
 Mail: geral@hidrosado.pt
 Site: www.hidrosado.pt



C / Motor  **Franklin Electric**

Código	Mod.	kW	HP	Ø	m3/h L/mim	0,6	1,2	1,8	2,4	3	4,5	6	7,5	Volts	Preço
						10	20	30	40	50	75	100	125		
05,7090	14 F	1,5	2,00	2"	Altura Manométrica	84	83	81	78	75	66	53	34	400	604,39 €
05,7091	21 F	2,2	3,00			127	124	120	116	112	100	79	55	400	761,22 €
05,7092	27 F	3,0	4,00			167	164	160	155	149	130	104	70	400	999,00 €
05,7093	34 F	4,0	5,50			205	202	198	193	186	165	131	88	400	1.167,95 €

Código	Mod.	kW	HP	Ø	m3/h L/mim	0,6	1,8	3,6	5,4	7,2	9	10,8	12,6	Volts	Preço
						10	30	60	90	120	150	180	210		
05,7050	7 G	1,1	1,50	2"	Altura Manométrica	54	51	46	40	33	26	17	8	230	507,75 €
05,7049						400	483,36 €								
05,7051	10 G	1,5	2,00			74	71	66	59	50	40	28	13	230	623,06 €
05,7031						400	569,69 €								
05,7032	14 G	2,2	3,00			93	91	85	77	66	51	34	15	400	707,04 €
05,7033	18 G	3,0	4,00			127	121	111	99	84	67	44	19	400	934,69 €
05,7034	24 G	4,0	5,50			168	161	149	132	112	89	61	28	400	1.098,77 €
05,7047	33 G	5,5	7,50			222	212	193	171	144	113	77	35	400	1.337,55 €

Código	Mod.	kW	HP	Ø	m3/h L/mim	1,2	2,4	4,8	7,2	9,6	12	14,4	16,8	Volts	Preço
						20	40	80	120	160	200	240	280		
05,7035	11 H	2,2	3,00	2"	Altura Manométrica	75	72	63	54	44	33	22	12	400	651,00 €
05,7036	13 H	3,0	4,00			95	91	84	75	63	49	32	13	400	895,71 €
05,7037	18 H	4,0	5,50			126	122	113	102	86	68	46	22	400	1.038,00 €
05,7038	25 H	5,5	7,50			165	162	153	136	122	98	68	33	400	1.237,24 €

Código	Mod.	kW	HP	Ø	m3/h L/mim	3	6	9	12	15	18	21	24	Volts	Preço
						50	100	150	200	250	300	350	400		
05,7048	10 I	2,2	3,00	2"	Altura Manométrica	60	53	46	39	31	23	15	6	400	707,65 €
05,7039	13 I	3,0	4,00			70	63	56	48	40	31	21	10	400	946,83 €
05,7040	18 I	4,0	5,50			100	90	79	67	54	41	26	11	400	1.109,59 €
05,7041	26 I	5,5	7,50			140	126	111	94	75	55	34	12	400	1.349,00 €
05,7072	33 I	7,5	10,00			190	171	149	126	102	76	49	20	400	1.905,00 €



Nota: Esta tabela pode ser alterada sem aviso prévio, preços sujeitos à taxa de I.v.a. em vigor.
 Setúbal, 01 de Janeiro de 2018.



Hidrosado, Lda.

Quinta Varzinha, Lote 25

2900-721 Setúbal

Telefone: 265537550

Fax: 265537551

Mail: geral@hidrosado.pt

Site: www.hidrosado.pt

ALANOL[®]
ELETROBOMBAS SUBMERSÍVEIS, S.A.

c/Motor

COVERGO[®]
SUBMERSIBLE MOTORS

Código	Mod.	HP	Ø	m ³ /h L/mim	0.3	0.6	0.9	1.2	1.5	1.8	2.1	2.4	2.7	3.0	3.3	3.6	Volts	Preço	
					5	10	15	20	25	30	35	40	45	50	55	60			
05,8001	17 C	0,75	1. ¼"	Altura Manométrica	85	81	73	67	58	45	32	22					230	411,42 €	
05,8011					400	399,59 €													
05,8002	21 C	0,75			101	94	86	77	67	52	37	26						230	428,97 €
05,8012					400	418,57 €													
05,8003	28 C	1,00			139	132	119	103	87	68	47	33						230	475,30 €
05,8013					400	466,22 €													
05,8004	35 C	1,50			175	166	150	132	113	88	66	40						230	570,00 €
05,8014					400	534,18 €													

Código	Mod.	HP	Ø	m ³ /h L/mim	0.3	0.6	0.9	1.2	1.5	1.8	2.1	2.4	2.7	3.0	3.3	3.6	Volts	Preço
					5	10	15	20	25	30	35	40	45	50	55	60		
05,8005	14 D	0,75	1. ¼"	Altura Manométrica	76	74	72	70	64	60	52	45	37	28	17	6	230	393,00 €
05,8015					400	382,65 €												
05,8006	18 D	1,00			99	95	92	89	84	79	70	60	49	37	21	7	230	422,75 €
05,8016					400	413,77 €												
05,8007	25 D	1,50			139	135	131	128	120	110	99	87	70	52	32	9	230	490,51 €
05,8017					400	479,38 €												
05,8036	34 D	2,00			186	182	176	169	158	147	132	115	94	70	42	11	230	586,83 €
05,8135					400	558,77 €												

Código	Mod.	HP	Ø	m ³ /h L/mim	0.6	1.2	1.8	2.4	3.0	3.6	4.2	4.8	5.4	6.0	6.6	Volts	Preço
					10	20	30	40	50	60	70	80	90	100	110		
05,8008	10 E	1,00	1. ¼"	Altura Manométrica	62	59	57	52	49	44	38	32	25	18	10	230	393,77 €
05,8018					400	384,79 €											
05,8009	15 E	1,50			96	93	89	84	78	70	60	50	38	25	13	230	456,12 €
05,8019					400	445,40 €											
05,8010	20 E	2,00			129	125	122	113	104	92	79	66	50	32	15	230	535,30 €
05,8020					400	507,00 €											
05,8021	32 E	3,00			197	187	175	162	148	131	113	93	71	48	25	400	676,93 €

Código	Mod.	HP	Ø	m ³ /h L/mim	0.6	1.8	3.6	5.4	7.2	9	10.8	12.6				Volts	Preço
					10	30	60	90	120	150	180	210					
05,8145	21 F	3	2"	A. Manométrica	127	124	120	116	112	100	79	55				400	634,79 €
05,8138	7 G	1,5			54	54	46	40	33	26	17	8				230	430,91 €
05,8139					400	419,60 €											
05,8137	10 G	2,00			74	71	66	59	50	40	28	13				230	506,53 €
05,8023					400	478,77 €											
05,8024	14 G	3,00			93	91	85	77	66	51	34	15				400	592,45 €
05,8025	18 G	4,00			127	121	111	99	84	67	44	19				400	744,49 €
05,8026	24 G	5,50			168	161	149	132	112	89	61	28				400	885,20 €

Código	Mod.	HP	Ø	m ³ /h L/mim	1.2	2.4	4.8	7.2	9.6	12	14.4	16.8				Volts	Preço
					20	40	80	120	160	200	240	280					
05,8028	11 H	3,00	2"	A. Manométrica	75	72	63	54	44	33	22	12				400	574,80 €
05,8029	13 H	4,00			95	91	84	75	63	49	32	13				400	690,92 €
05,8030	18 H	5,50			126	122	113	102	86	68	46	22				400	838,47 €
05,8031	25 H	7,50			165	162	153	136	122	98	68	33				400	1.073,70 €

Código	Mod.	HP	Ø	m ³ /h L/mim	3	6	9	12	15	18	21	24				Volts	Preço
					50	100	150	200	250	300	350	400					
05,8032	10 I	3,00	2"	A. Manométrica	60	53	46	39	31	23	15	6				400	598,88 €
05,8033	13 I	4,00			70	63	56	48	40	31	21	10				400	734,80 €
05,8034	18 I	5,50			100	90	79	67	54	41	26	11				400	904,49 €
05,8035	26 I	7,50			140	126	111	94	75	55	34	12				400	1.184,80 €

Nota: Esta tabela pode ser alterada sem aviso prévio, preços sujeitos à taxa de I.v.a. em vigor.

Setúbal, 01 de Janeiro de 2018.

Pág.: 09





Hidrosado, Lda.

Quinta Varzinha, Lote 25

2900-721 Setúbal

Telefone: 265537550

Fax: 265537551

Mail: geral@hidrosado.pt

Site: www.hidrosado.pt



Hidráulicos Submersíveis em Aço Inox

Código	Hidráulico	Saída	Preço
05.7100	14 C	1. ¼"	183,47 €
05.7101	17 C	1. ¼"	201,33 €
05.7102	21 C	1. ¼"	220,51 €
05.7103	28 C	1. ¼"	300,51 €
05.7104	35 C	1. ¼"	341,73 €
05.7105	42 C	1. ¼"	334,90 €
05.7106	10 D	1. ¼"	162,35 €
05.7107	14 D	1. ¼"	183,47 €
05.7108	18 D	1. ¼"	205,10 €
05.7109	25 D	1. ¼"	242,04 €
05.7110	34 D	1. ¼"	305,20 €
05.7111	47 D	1. ¼"	369,08 €
05.7112	60 D	1. ¼"	463,88 €
05.7113	7 E	1. ¼"	152,14 €
05.7114	10 E	1. ¼"	171,94 €
05.7115	15 E	1. ¼"	206,02 €
05.7116	20 E	1. ¼"	259,80 €
05.7117	32 E	1. ¼"	344,59 €
05.7118	39 E	1. ¼"	433,67 €
05.7155	14 F	2"	238,87 €
05.7156	21 F	2"	307,14 €
05.7157	27 F	2"	346,22 €
05.7158	34 F	2"	430,30 €
05.7119	10 G	2"	204,29 €
05.7120	14 G	2"	253,37 €
05.7121	18 G	2"	281,84 €
05.7122	24 G	2"	360,92 €
05.7123	33 G	2"	460,51 €
05.7124	11 H	2"	203,06 €
05.7125	13 H	2"	243,27 €
05.7126	18 H	2"	300,20 €
05.7127	25 H	2"	381,33 €
05.7128	10 I	2"	259,80 €
05.7129	13 I	2"	293,88 €
05.7130	18 I	2"	371,94 €
05.7131	26 I	2"	471,94 €
05.7132	33 I	2"	658,16 €



Nota: Esta tabela pode ser alterada sem aviso prévio, preços sujeitos à taxa de I.v.a. em vigor.

Setúbal, 01 de Janeiro de 2018.



Hidrosado, Lda.

Quinta Varzinha, Lote 25

2900-721 Setúbal

Telefone: 265537550

Fax: 265537551

Mail: geral@hidrosado.pt

Site: www.hidrosado.pt

Hidráulico totalmente em aço inox AISI 304

- Série SP -

Camisa - Difusores - Turbina - Veio - União



Modelo	kW	HP	Ø	Motor Franklin Electric				Motor COVERCO			
				Código	230V	Código	400V	Código	230V	Código	400V
SP 10/18	0,75	1	1.¼"	05,9021	709,23 €	05,9031	693,23 €	05,9051	626,69 €	05,9061	617,13 €
SP 18/12	0,75	1		05,9022	614,83 €	05,9032	598,83 €	05,9052	532,29 €	05,9062	522,73 €
SP 18/15	1,1	1,5		05,9023	712,78 €	05,9033	692,20 €	05,9053	619,73 €	05,9063	605,79 €
SP 18/25	1,5	2		05,9024	957,08 €	05,9034	906,16 €	05,9054	834,87 €	05,9064	802,83 €
SP 25/08	0,75	1	1.½"	05,9025	559,54 €	05,9035	543,54 €	05,9055	477,00 €	05,9065	467,44 €
SP 25/12	1,1	1,5		05,9026	669,46 €	05,9036	648,88 €	05,9056	576,41 €	05,9066	562,47 €
SP 25/17	1,5	2		05,9027	833,72 €	05,9037	784,33 €	05,9057	713,04 €	05,9067	681,00 €
SP 25/25	2,2	3			05,9038	1.006,46 €			05,9068	899,06 €	
SP 40/10	1,5	2	2"			05,9039	940,02 €			05,9069	834,69 €
SP 40/15	2,2	3				05,9040	1.220,22 €			05,9070	1.120,82 €
SP 40/18	3,0	4				05,9041	1.571,42 €			05,9071	1.352,01 €
SP 40/25	4,0	5,5				05,9043	1.965,36 €			05,9073	1.710,39 €
SP 70/13	4,0	5,5				05,9044	1.754,23 €			05,9074	1.499,26 €



Hidráulicos		
Modelo	Código	Preço
SP 10/18	05,9101	382,81 €
SP 18/12	05,9102	288,41 €
SP 18/15	05,9103	337,51 €
SP 18/25	05,9104	499,40 €
SP 25/08	05,9105	233,12 €
SP 25/12	05,9106	294,19 €
SP 25/17	05,9107	377,57 €
SP 25/25	05,9108	510,35 €
SP 40/10	05,9109	533,26 €
SP 40/15	05,9110	732,11 €
SP 40/18	05,9111	851,80 €
SP 40/25	05,9113	1.130,00 €
SP 70/13	05,9114	918,87 €

Gráfico

Modelo	kW	HP	Q = DÉBITO																											
			m³/h	0	0,3	0,6	0,9	1,2	1,5	1,8	2,1	2,4	2,7	3	3,6	4,2	4,8	5,4	6	7	8	9	10	10,8	12	13,5	15,0	16,5	18,0	
			l/min	0	5	10	15	20	25	30	35	40	45	50	60	70	80	90	100	120	140	150	160	180	200	225	250	275	300	
Ø			H = ALTURA MANOMÉTRICA TOTAL EM METROS DE COLUMNA DE ÁGUA																											
SP 10/18	0,75	1	1.¼"	106	103	100	98	92	84	77	66	51																		
SP 18/12	0,75	1		78				67	65	62	59	56	52	42	28															
SP 18/15	1,1	1,5		97				84	81	78	74	71	67	52	38															
SP 18/25	1,5	2		162				140	134	128	121	113	106	86	58															
SP 25/08	0,75	1	1.½"	57				44	43	42	41	40	38	35	32	28	22													
SP 25/12	1,1	1,5		75				68	66	65	64	63	58	53	49	42	36													
SP 25/17	1,5	2		106				95	92	90	87	85	79	73	67	58	50													
SP 25/25	2,2	3	156				140	136	131	129	127	118	110	100	90	74														
SP 40/10	1,5	2	2"	58							52	52	51	51	50	50	49	49	46	40	37	34	27							
SP 40/15	2,2	3		86							79	78	77	76	75	73	72	70	66	60	55	50	40							
SP 40/18	3,0	4		103						91	90	89	88	87	85	83	81	77	70	65	60	48								
SP 40/25	4,0	5,5		144						131	130	128	126	122	119	116	113	107	97	89	81	61								
SP 70/13	4,0	5,5		85														75	72	70	68	67	65	60	55	49	42	34		

Nota: Esta tabela pode ser alterada sem aviso prévio, preços sujeitos à taxa de I.v.a. em vigor.
Setúbal, 01 de Janeiro de 2018.



Hidrosado, Lda.

Quinta Varzinha, Lote 25

2900-721 Setúbal

Telefone: 265537550

Fax: 265537551

Mail: geral@hidrosado.pt

Site: www.hidrosado.pt



E-Tech
by Franklin Electric

COVERCO
SUBMERSIBLE MOTORS



Modelo	kW	HP	Q = DÉBITO																Código	Preço	Código	Preço
			m³/h	0	0,3	0,6	0,9	1,2	1,8	2,1	2,4	2,7	3,0	3,6	4,2	4,8	5,4	6				
			l/seg	0	0,08	0,17	0,25	0,33	0,50	0,58	0,67	0,75	0,83	1	1,17	1,33	1,5	1,67				
			Ø	H = ALTURA MANOMÉTRICA TOTAL EM METROS DE COLUNA DE ÁGUA																		
VS 1/10	0,37	0,50	1. 1/4"	68	59	53	45	35	2									05,3600	373,84 €			
VS 1/13	0,37	0,50		83	71	64	54	39	3										05,3601	385,92 €		
VS 1/19	0,55	0,75		118	104	94	80	57	5										05,3602	409,52 €	05,3623	395,58 €
VS 1/26	0,75	1,0		156	142	126	105	75	7										05,3603	460,09 €	05,3624	447,16 €
VS 1/38	1,1	1,5		241	215	193	162	117	9										05,3604	538,36 €	05,3625	521,10 €
VS 1/42	1,5	2,0		265	252	222	183	133	7										05,3605	573,34 €	05,3626	576,68 €
VS 2/5	0,37	0,50		34				30	27	25	22	18	14	4					05,3606	353,17 €		
VS 2/7	0,37	0,50		45				43	37	35	30	25	20	6,6					05,3607	360,22 €		
VS 2/10	0,55	0,75		67				60	54	49	43	36	28	10					05,3608	373,36 €	05,3627	359,43 €
VS 2/14	0,75	1,0		94				85	75	68	60	50	39	14					05,3609	397,65 €	05,3628	381,92 €
VS 2/20	1,1	1,5		133				120	107	97	86	72	56	17					05,3610	445,82 €	05,3629	428,55 €
VS 2/27	1,5	2,0		189				164	145	132	115	97	75	20					05,3611	505,21 €	05,3630	500,10 €
VS 2/39	2,2	3,0		259				235	209	190	167	140	110	23							05,3631	613,23 €
VS 3/4	0,37	0,50		30				27	25	24	23	21	20	16	12				05,3612	352,98 €		
VS 3/7	0,55	0,75		50				42	39	38	36	34	31	25	18				05,3613	372,15 €	05,3632	358,21 €
VS 3/10	0,75	1,0		68				60	56	54	53	48	44	35	27				05,3614	391,56 €	05,3633	375,83 €
VS 3/15	1,1	1,5		100				92	86	78	75	72	63	52	33				05,3615	446,42 €	05,3634	417,82 €
VS 3/20	1,5	2,0		133				119	115	107	98	95	84	66	50				05,3616	486,60 €	05,3635	479,35 €
VS 3/30	2,2	3,0		199				183	169	160	151	138	125	98	67						05,3636	604,64 €
VS 3/37	3,0	4,0		245				225	211	202	184	174	157	127	81						05,3637	784,51 €
VS 4/4	0,37	0,5		25				23	23	22	21	20	19	17	14	11	8		05,3617	353,09 €		
VS 4/7	0,55	0,75		45				40	39	38	36	35	32	28	23	20	14		05,3618	371,70 €	05,3638	357,76 €
VS 4/9	0,75	1,0		59				53	52	50	49	47	42	38	32	24	16		05,3619	381,09 €	05,3639	365,36 €
VS 4/10	0,75	1,0		64				57	56	55	54	52	47	42	35	28	19		05,3620	391,91 €	05,3640	376,18 €
VS 4/14	1,1	1,5		89				80	78	77	75	72	65	59	50	40	26		05,3621	430,73 €	05,3641	413,47 €
VS 4/18	1,5	2,0		114				104	101	99	95	93	85	80	64	50	34		05,3622	478,40 €	05,3642	470,52 €
VS 4/27	2,2	3,0		170				154	151	148	145	139	127	114	95	75	50				05,3643	584,38 €
VS 4/32	3,0	4,0		222				183	180	175	170	165	150	135	113	90	60				05,3644	762,35 €
VS 4/40	3,7	5,0		252				229	225	223	220	212	189	166	141	113	75				05,3645	868,23 €
VS 4/44	3,7	5,0		278				252	247	242	235	226	207	185	155	124	83				05,3646	888,37 €

Nota: Esta tabela pode ser alterada sem aviso prévio, preços sujeitos à taxa de I.v.a. em vigor.

Setúbal, 01 de Janeiro de 2018.



Hidrosado, Lda
 Quinta Varzinha, Lote 25
 2900-721 Setúbal
 Telefone: 265537550
 Fax: 265537551
 Mail: geral@hidrosado.pt
 Site: www.hidrosado.pt



E-Tech
 by Franklin Electric

COVERCO
 SUBMERSIBLE MOTORS



Modelo	kW	HP	Q = DÉBITO														Código	Preço	Código	Preço		
			m³/h	0	1,8	2,1	2,4	2,7	3	3,3	3,6	4,2	4,8	6	7	7,2					8,0	9
			l/seg	0	0,50	0,58	0,67	0,75	0,83	0,92	1	1,17	1,33	1,67	1,94	2					2,22	2,50
H = ALTURA MANOMÉTRICA TOTAL EM METROS DE COLUNA DE ÁGUA																				230V		400V
VS 6/6	0,75	1,0	36				33	33	32	32	31	30	26	23	22	18	13	05,3647	381,79 €	05,3657	365,97 €	
VS 6/9	1,1	1,5	53				49	48	48	47	46	44	39	33	32	25	17	05,3648	424,69 €	05,3658	407,43 €	
VS 6/13	1,5	2,0	77				74	73	72	71	69	66	60	52	50	43	32	05,3649	460,15 €	05,3659	471,91 €	
VS 6/19	2,2	3,0	110				105	104	103	102	99	95	85	74	72	60	41			05,3660	576,94 €	
VS 6/26	3,0	4,0	150				143	141	139	137	132	126	110	94	90	73	49			05,3661	758,72 €	
VS 6/31	3,7	5,0	185				177	175	172	169	164	155	136	115	110	90	58			05,3662	860,52 €	
VS 6/34	4,0	5,5	200				192	189	185	182	175	165	145	123	118	95	64			05,3663	882,32 €	
VS 6/45	5,5	7,5	269				257	253	249	245	235	223	191	160	155	128	93			05,3664	1.080,64 €	
VS 8/4	0,75	1,0	25			24	24	23	23	22	20	20	17	15	14	12	8	05,3650	373,30 €	05,3665	357,77 €	
VS 8/6	1,1	1,5	38			36	36	35	35	33	30	30	26	24	21	19	10	05,3651	405,09 €	05,3666	387,83 €	
VS 8/9	1,5	2,0	57			54	53	52	50	49	45	45	39	35	32	28	15	05,3652	453,99 €	05,3667	442,92 €	
VS 8/14	2,2	3,0	88			85	83	80	78	75	70	68	60	54	48	43	22			05,3668	539,54 €	
VS 8/18	3,0	4,0	113			108	106	104	101	92	90	88	75	70	61	55	32			05,3669	709,94 €	
VS 8/21	4,0	5,5	137			131	130	129	126	121	113	111	97	90	81	73	40			05,3670	798,00 €	
VS 8/23	4,0	5,5	150			141	138	137	131	126	117	115	100	91	82	75	41			05,3671	810,46 €	
VS 8/32	5,5	7,5	206			193	189	185	179	173	160	158	140	127	117	106	59			05,3672	979,03 €	
VS 8/42	7,5	10,0	273			252	250	245	237	227	210	206	181	165	150	135	82			05,3673	1.255,45 €	
VS 9/7	1,1	1,5	40	36	35	34	33	32	30	29	28	26	23	19	16	15	11	05,3653	453,07 €	05,3674	436,61 €	
VS 9/10	1,5	2,0	57	53	52	51	48	48	45	43	41	39	34	29	24	24	18	05,3654	519,17 €	05,3675	515,54 €	
VS 9/14	2,2	3,0	77	69	67	65	61	61	58	55	52	49	42	35	30	28	21			05,3676	629,88 €	
VS 9/17	3,0	4,0	96	88	86	83	79	79	75	72	69	65	57	48	42	40	31			05,3677	813,44 €	
VS 9/20	4,0	5,5	116	107	105	102	97	96	91	89	83	80	69	58	50	49	39			05,3678	920,67 €	
VS 9/22	4,0	5,5	126	115	113	110	105	103	98	95	89	84	73	62	54	53	40			05,3679	950,59 €	
VS 9/28	5,5	7,5	165	154	150	145	138	136	131	124	121	117	102	90	79	78	64			05,3680	1.131,44 €	
VS 9/35	7,5	10,0	210	195	189	184	175	173	165	164	156	148	132	116	103	100	85			05,3681	1.483,51 €	
VS 10/5	1,1	1,5	30	25	25	24	23	22	21	20	18	16	13	12	11	8	5	05,3655	432,67 €	05,3682	415,40 €	
VS 10/7	1,5	2,0	42	36	34	33	33	31	30	28	27	23	20	17	16	12	8	05,3656	481,34 €	05,3683	473,39 €	
VS 10/11	2,2	3,0	64	54	53	51	50	47	45	43	40	35	29	25	23	18	11			05,3684	588,41 €	
VS 10/14	3,0	4,0	82	69	68	66	65	61	58	56	53	45	38	32	32	24	20			05,3685	769,86 €	
VS 10/17	4,0	5,5	101	88	88	84	82	79	75	73	68	59	51	45	43	34	22			05,3686	878,78 €	
VS 10/18	4,0	5,5	107	93	92	89	87	83	80	77	72	63	54	48	45	36	26			05,3687	891,45 €	
VS 10/25	5,5	7,5	150	130	128	124	121	117	112	108	103	91	80	71	68	55	39			05,3688	1.091,30 €	
VS 10/32	7,5	10,0	194	168	167	160	157	152	145	140	133	120	105	95	91	74	55			05,3689	1.417,60 €	
VS 15/8	2,2	3,0	46	36	35	33	32	30	29	27	26	25	21	20	18	15	10			05,3690	573,58 €	
VS 15/10	3,0	4,0	58	45	43	41	40	38	36	34	33	30	27	25	22	19	13			05,3691	746,45 €	
VS 15/11	3,0	4,0	63	48	45	43	41	39	37	35	33	30	26	24	21	18	11			05,3692	770,53 €	
VS 15/12	4,0	5,5	69	54	52	50	48	45	43	41	39	37	32	30	26	23	16			05,3693	854,81 €	
VS 15/13	4,0	5,5	75	61	56	53	50	47	45	42	40	38	33	30	26	22	13			05,3694	873,87 €	
VS 15/15	4,0	5,5	87	72	66	61	58	55	52	49	47	45	39	35	31	26	15			05,3695	923,53 €	
VS 15/16	5,5	7,5	92	73	69	66	63	60	58	55	52	49	43	39	35	31	21			05,3696	1.052,46 €	
VS 15/20	5,5	7,5	121	98	92	86	81	76	71	67	62	58	50	45	40	34	18			05,3697	1.175,20 €	
VS 15/21	7,5	10,0	121	95	91	87	84	80	75	72	68	64	56	51	46	40	27			05,3698	1.412,77 €	
VS 15/28	7,5	10,0	165	130	121	112	105	98	92	86	80	74	62	56	49	42	25			05,3699	1.458,14 €	

Nota: Esta tabela pode ser alterada sem aviso prévio, preços sujeitos à taxa de I.v.a. em vigor.
 Setúbal, 01 de Janeiro de 2018. Pág.: 13



Hidrosado, Lda
 Quinta Varzinha, Lote 25
 2900-721 Setúbal
 Telefone: 265537550
 Fax: 265537551
 Mail: geral@hidrosado.p.
 Site: www.hidrosado.pt



E-Tech
 by Franklin Electric



Franklin Electric



Modelo	kW	HP	Q = DÉBITO																Código	Preço	Código	Preço
			m³/h	0	0,3	0,6	0,9	1,2	1,8	2,1	2,4	2,7	3,0	3,6	4,2	4,8	5,4	6				
			l/seg	0	0,08	0,17	0,25	0,33	0,50	0,58	0,67	0,75	0,83	1	1,17	1,33	1,5	1,67				
			Ø	H = ALTURA MANOMÉTRICA TOTAL EM METROS DE COLUNA DE ÁGUA																		
																		230V	400V			
VS 1/10	0,37	0,50	68	59	53	45	35	2										05,3700	433,41 €			
VS 1/13	0,37	0,50	83	71	64	54	39	3										05,3701	445,13 €			
VS 1/19	0,55	0,75	118	104	94	80	57	5										05,3702	484,90 €	05,3723	472,03 €	
VS 1/26	0,75	1,0	156	142	126	105	75	7										05,3703	552,99 €	05,3724	535,65 €	
VS 1/38	1,1	1,5	241	215	193	162	117	9										05,3704	659,64 €	05,3725	637,27 €	
VS 1/42	1,5	2,0	265	252	222	183	133	7										05,3705	775,52 €	05,3726	719,35 €	
VS 2/5	0,37	0,50	34				30	27	25	22	18	14	4					05,3706	413,36 €			
VS 2/7	0,37	0,50	45				43	37	35	30	25	20	6,6					05,3707	421,17 €			
VS 2/10	0,55	0,75	67				60	54	49	43	36	28	10					05,3708	449,82 €	05,3727	436,95 €	
VS 2/14	0,75	1,0	94				85	75	68	60	50	39	14					05,3709	489,71 €	05,3728	472,37 €	
VS 2/20	1,1	1,5	133				120	107	97	86	72	56	17					05,3710	569,87 €	05,3729	547,50 €	
VS 2/27	1,5	2,0	189				164	145	132	115	97	75	20					05,3711	701,25 €	05,3730	645,08 €	
VS 2/39	2,2	3,0	259				235	209	190	167	140	110	23							05,3731	793,28 €	
VS 3/4	0,37	0,50	30				27	25	24	23	21	20	16	12				05,3712	413,18 €			
VS 3/7	0,55	0,75	50				42	39	38	36	34	31	25	18				05,3713	448,65 €	05,3732	435,78 €	
VS 3/10	0,75	1,0	68				60	56	54	53	48	44	35	27				05,3714	483,80 €	05,3733	466,46 €	
VS 3/15	1,1	1,5	100				92	86	78	75	72	63	52	33				05,3715	559,45 €	05,3734	537,08 €	
VS 3/20	1,5	2,0	133				119	115	107	98	95	84	66	50				05,3716	681,12 €	05,3735	624,95 €	
VS 3/30	2,2	3,0	199				183	169	160	151	138	125	98	67						05,3736	784,95 €	
VS 3/37	3,0	4,0	245				225	211	202	184	174	157	127	81						05,3737	1.057,14 €	
VS 4/4	0,37	0,5	25				23	23	22	21	20	19	17	14	11	8		05,3717	413,28 €			
VS 4/7	0,55	0,75	45				40	39	38	36	35	32	28	23	20	14		05,3718	448,20 €	05,3738	435,34 €	
VS 4/9	0,75	1,0	59				53	52	50	49	47	42	38	32	24	16		05,3719	473,65 €	05,3739	456,30 €	
VS 4/10	0,75	1,0	64				57	56	55	54	52	47	42	35	28	19		05,3720	484,14 €	05,3740	466,80 €	
VS 4/14	1,1	1,5	89				80	78	77	75	72	65	59	50	40	26		05,3721	555,23 €	05,3741	532,86 €	
VS 4/18	1,5	2,0	114				104	101	99	95	93	85	80	64	50	34		05,3722	672,55 €	05,3742	616,38 €	
VS 4/27	2,2	3,0	170				154	151	148	145	139	127	114	95	75	50				05,3743	765,29 €	
VS 4/32	3,0	4,0	222				183	180	175	170	165	150	135	113	90	60				05,3744	1.033,70 €	
VS 4/40	3,7	5,0	252				229	225	223	220	212	189	166	141	113	75				05,3745	1.171,69 €	
VS 4/44	3,7	5,0	278				252	247	242	235	226	207	185	155	124	83				05,3746	1.191,22 €	

Nota: Esta tabela pode ser alterada sem aviso prévio, preços sujeitos à taxa de I.v.a. em vigor.
 Setúbal, 01 de Janeiro de 2018.



Hidrosado, Lda.
 Quinta Varzinha, Lote 25
 2900-721 Setúbal
 Telefone: 265537550
 Fax: 265537551
 Mail: geral@hidrosado.pt
 Site: www.hidrosado.pt



Hidráulicos

Código	Modelo	Ø	Preço	
05,3500	VS 1/10	1.¼"	136,07 €	
05,3501	VS 1/13		147,79 €	
05,3502	VS 1/19		166,46 €	
05,3503	VS 1/26		209,56 €	
05,3504	VS 1/38		263,72 €	
05,3505	VS 1/42		281,82 €	
05,3506	VS 2/5		116,02 €	
05,3507	VS 2/7		123,83 €	
05,3508	VS 2/10		131,38 €	
05,3509	VS 2/14		146,28 €	
05,3510	VS 2/20		173,96 €	
05,3511	VS 2/27		207,55 €	
05,3512	VS 2/39		259,90 €	
05,3513	VS 3/4		115,83 €	
05,3514	VS 3/7		130,21 €	
05,3515	VS 3/10		140,36 €	
05,3516	VS 3/15		163,54 €	
05,3517	VS 3/20		187,42 €	
05,3518	VS 3/30		251,56 €	
05,3519	VS 3/37		292,19 €	
05,3520	VS 4/4		115,94 €	
05,3521	VS 4/7		129,77 €	
05,3522	VS 4/9		130,21 €	
05,3523	VS 4/10		140,70 €	
05,3524	VS 4/14		159,32 €	
05,3525	VS 4/18		178,85 €	
05,3526	VS 4/27		231,90 €	
05,3527	VS 4/32		268,75 €	
05,3528	VS 4/40		308,07 €	
05,3529	VS 4/44		327,60 €	
05,3530	VS 6/6		2"	130,81 €
05,3531	VS 6/9			153,46 €
05,3532	VS 6/13	180,21 €		
05,3533	VS 6/19	224,69 €		
05,3534	VS 6/26	265,23 €		
05,3535	VS 6/31	300,60 €		
05,3536	VS 6/34	321,74 €		
05,3537	VS 6/45	414,53 €		



Código	Modelo	Ø	Preço
05,3538	VS 8/4	1.5"	122,66 €
05,3539	VS 8/6		134,45 €
05,3540	VS 8/9		152,08 €
05,3541	VS 8/14		188,41 €
05,3542	VS 8/18		217,92 €
05,3543	VS 8/21		239,97 €
05,3544	VS 8/23		252,03 €
05,3545	VS 8/32		315,96 €
05,3546	VS 8/42		381,90 €
05,3547	VS 9/7		181,77 €
05,3548	VS 9/10		222,53 €
05,3549	VS 9/14		276,04 €
05,3550	VS 9/17		318,31 €
05,3551	VS 9/20		358,93 €
05,3552	VS 9/22		387,97 €
05,3553	VS 9/28		463,80 €
05,3554	VS 9/35		603,13 €
05,3555	VS 10/5	2"	161,20 €
05,3556	VS 10/7		181,64 €
05,3557	VS 10/11		235,81 €
05,3558	VS 10/14		276,04 €
05,3559	VS 10/17		318,31 €
05,3560	VS 10/18		330,60 €
05,3561	VS 10/25		424,87 €
05,3562	VS 10/32		539,19 €
05,3563	VS 15/8		221,43 €
05,3564	VS 15/10		253,33 €
05,3565	VS 15/11		276,69 €
05,3566	VS 15/12		295,05 €
05,3567	VS 15/13	313,54 €	
05,3568	VS 15/15	361,72 €	
05,3569	VS 15/16	387,19 €	
05,3570	VS 15/20	506,25 €	
05,3571	VS 15/21	534,51 €	
05,3572	VS 15/28	578,52 €	

Nota: Esta tabela pode ser alterada sem aviso prévio, preços sujeitos à taxa de I.v.a. em vigor.
 Setúbal, 01 de Janeiro de 2018.

Motores Submersíveis e Hidráulicos - 6"

Cabos eléctricos e condensadores



Modelo	kW	HP	Ø	Motor			
				Arranque Direto - DOL		Estrela Triângulo - Y/Δ	
				Código	400V	Código	400V
6K75	5,5	7,5	6"	06.2050	1.055,00 €	06,2065	1.055,00 €
6K10	7,5	10		06.2051	1.129,80 €	06,2066	1.129,80 €
6K125	9,3	12,5		06.2052	1.168,43 €	06,2067	1.168,43 €
6K15	11	15		06.2053	1.230,98 €	06,2068	1.230,98 €
6K175	13	17,5		06.2054	1.321,68 €	06,2069	1.321,68 €
6K20	15	20		06.2055	1.540,53 €	06,2070	1.540,53 €
6K25	18,5	25		06.2056	1.615,34 €	06,2071	1.615,34 €
6K30	22	30		06.2057	1.818,89 €	06,2072	1.818,89 €
6K35	26	35		06.2058	2.097,78 €	06,2073	2.097,78 €
6K40	30	40		06.2059	2.296,39 €	06,2074	2.296,39 €
6K50	37	50		06.2060	2.699,14 €	06,2075	2.699,14 €
6K60	45	60		06.2061	3.176,11 €	06,2076	3.176,11 €

Hidráulicos - aço inox AISI 304 Série SS - 6"



Modelo	kW	HP	Q = DÉBITO													Código	Preço	
			m³/h	0	10	12	14	16	19	24	28	38	42	51				
			l/s	0	2,78	3,06	3,33	3,61	3,89	4,17	4,44	4,72	5,00	5,28				
			Ø	H = Altura manométrica total de coluna de água														
SS 615/08	4	5,5	2. 1/2"	96	78	72	68	61	50								06,3000	994,76 €
SS 615/09	4	5,5		108	88	81	76	69	56								06,3001	1.084,03 €
SS 615/11	7,5	5,5		132	107	99	93	84	69								06,3002	1.251,87 €
SS 615/13	7,5	10		156	127	117	110	100	81								06,3003	1.563,86 €
SS 630/10	7,5	10	3"	98				94	90	82	75	45				06,3004	1.338,82 €	
SS 630/12	9,2	12,5		117				113	108	98	90	54				06,3005	1.521,90 €	
SS 630/15	11	15		147				141	135	123	113	68				06,3006	1.796,75 €	
SS 636/12	13	17,5		137						116	112	90	84	63		06,3007	1.724,79 €	
SS 636/13	15	20		148						126	121	98	91	69		06,3008	1.843,82 €	



Cabos p/motores



Código	Designação	medida	Preço
11.4060	Cabo Peq. c/junção inox	1,5 Mts	41,83 €
11.4061	Cabo Gr. c/junção inox	2,5 Mts	57,16 €

Condensadores p/motores



11,2041	Condensador	8 a 10 mf	4,61 €
11,2043	Condensador	14 a 16 mf	5,68 €
11,2023	Condensador	20 a 25 mf	6,62 €
11,2024	Condensador	30 mf	6,86 €
11,2025	Condensador	40 mf	7,38 €
11,2026	Condensador	50 mf	9,38 €
11,2047	Condensador	64 a 98 mf (Rabor)	10,30 €



Hidrosado, Lda.

Quinta Varzinha, Lote 25

2900-721 Setúbal

Telefone: 265537550

Fax: 265537551

Mail: geral@hidrosado.pt

Site: www.hidrosado.pt



Eletróbombas submersíveis Alanol para poço

Código	Mod.	HP	Ø	m3/h	0,5	1	2	3	4	4,5					Volts	Preço	
05,7060	VN 3/5 F	1,00	1.¼"	Altura Manométrica	55	52	45	40	30	22					230	485,60 €	
05,7061	VN 3/6 F	1,00			65	62	56	48	35	30						230	505,90 €
05,7062	VN 3/7 F	1,50			78	72	65	55	45	35						230	541,70 €
05,7063	VN 3/8 F	1,50			88	82	74	65	50	40						230	584,00 €
05,7065	VN 3/8										400	539,00 €					
05,7064	VN 3/9 F	2,00			100	95	85	70	55	45						230	605,20 €
05,7066	VN 3/9										400	647,50 €					

Código	Mod.	HP	Ø	m3/h	1	2	3	4	5	6	7,5				Volts	Preço	
05,7054	VN 5/5 F	1,50	1.¼"	Altura Manométrica	55	52	49	45	42	35	22				230	503,20 €	
05,7068	VN 5/6 F	1,50			64	62	58	55	50	45	30					230	541,70 €
05,7057	VN 5/6											400	481,20 €				
05,7055	VN 5/7 F	2,00			75	72	68	65	58	50	35					230	603,90 €
05,7058	VN 5/7											400	520,70 €				
05,7056	VN 5/8 F	2,00			90	83	80	72	67	58	40					230	651,60 €
05,7069	VN 5/8											400	568,30 €				
05,7059	VN 5/9	3,00	100	93	88	82	75	66	40				400	615,70 €			

Código	Mod.	HP	Ø	m3/h	1	2	3	4	5	6	7,5	9	10	12	Volts	Preço
05,7075	VN 9/3	1,50	1.¼"	Altura Manométrica	35,1	35	34,5	34	33	31	30	28	25	20	230	559,50 €
05,7076	VN 9/3 F														400	601,80 €
05,7077	VN 9/4	2,00			46	45	43	42	41	40	39	38	35	28	230	637,90 €
05,7078	VN 9/4 F														400	680,20 €
05,7079	VN 9/4 T	3,00			59	58	56	55	52	50	48	45	43	34	230	724,30 €
05,7080	VN 9/5														400	656,80 €
05,7081	VN 9/5 T	3,00			69	68	67	65	63	61	58	55	51	41	230	820,00 €
05,7082	VN 9/6														400	753,30 €
05,7083	VN 9/6 T	4,00			81	79	78	75	73	72	69	64	60	49	400	853,00 €
05,7084	VN 9/7 T														400	990,80 €
05,7085	VN 9/8 T	4,00	92	90	88	85	83	81	79	72	68	55	400	990,80 €		
05,7086	VN 9/9 T												400	1.151,60 €		

Eletróbombas submersíveis para poço

Código	Mod.	HP	Kw	Ø	m3/h	0,3	0,9	1,5	2,4	3,0	3,9	4,8	5,4		Volts	Preço
05,9014	SM A 40G	0,8	0,6	1.¼"	L/mim	5	15	25	40	50	65	80	90		230	324,59 €
05,9015						38	35	32	28	24	18	11	3	400	315,58 €	
05,9016	SM A 60G	1,2	0,9	1.¼"	H (m)	58	55	51	46	40	32	22	8	230	350,37 €	
05,9017														400	336,19 €	
05,9018	SM A 80G	1,8	1,3	1.¼"	78	73	68	62	55	44	33	14	230	391,57 €		
05,9019													400	377,40 €		

Nota: Eletróbombas equipadas com 20 metros de cabo eléctrico neoprene.

Eletróbombas 230V com boiador incluído.



Nota: Esta tabela pode ser alterada sem aviso prévio, preços sujeitos à taxa de I.v.a. em vigor.

Setúbal, 01 de Janeiro de 2018.

Pág.: 18



Hidrosado, Lda.
 Quinta Varzinha, Lote 25
 2900-721 Setúbal
 Telefone: 265537550
 Fax: 265537551
 Mail: geral@hidrosado.pt
 Site: www.hidrosado.pt

Motores submersíveis



Motores Submersíveis 4" - Franklin Electric - c/cabo elétrico



kW	HP	C. Axial	Volts	Código	Preço
0,37	0,50	1 500	230	06,2000	280,64 €
0,55	0,75	1 500	230	06,2001	300,26 €
0,75	1,00	1 500	230	06,2002	322,21 €
1,1	1,50	3 000	230	06,2003	370,33 €
1,5	2,00	3 000	230	06,2004	451,21 €
0,55	0,75	1 500	400	06,2005	291,35 €
0,75	1,00	1 500	400	06,2006	310,42 €
1,1	1,50	3 000	400	06,2007	354,69 €
1,5	2,00	3 000	400	06,2008	406,76 €
2,2	3,00	3 000	400	06,2009	496,11 €
2,2	3,00	6 500	400	06,2010	684,36 €
3,0	4,00	6 500	400	06,2011	719,62 €
4,0	5,50	6 500	400	06,2012	835,36 €
5,5	7,50	6 500	400	06,2013	939,90 €
7,5	10,00	6 500	400	06,2014	1.213,64 €

Motores Submersíveis 6" - Franklin Electric - c/cabo elétrico



kW	HP	Carga Axial	Volts	código	Preço Arranque directo	código	Preço Estrela Triângulo
5,5	7,50	15 500	400	06,1014	1.404,86 €	06,1028	1.510,92 €
7,5	10,00	15 500	400	06,1015	1.480,00 €	06,1029	1.586,46 €
9,3	12,50	15 500	400	06,1022	1.585,82 €	06,1030	1.692,10 €
11,0	15,00	15 500	400	06,1016	1.655,53 €	06,1031	1.771,92 €
15,0	20,00	15 500	400	06,1017	1.946,00 €	06,1032	2.052,10 €
18,5	25,00	15 500	400	06,1023	2.112,96 €	06,1033	2.219,36 €
22,0	30,00	15 500	400	06,1024	2.374,82 €	06,1034	2.481,21 €
30,0	40,00	15 500	400	06,1025	3.088,50 €	06,1035	3.155,46 €
37,00	50,00	15 500	400	06,1026	4.616,78 €	06,1036	4.690,60 €
45,00	60,00	15 500	400	06,1027	5.507,14 €		

Motores Submersíveis 4" - COVERCO - c/cabo elétrico



kW	HP	C. Axial	Volts	Código	Preço
0,37	0,50	1 500	230	05,8080	222,21 €
0,55	0,75	1 500	230	05,8081	231,32 €
0,75	1,00	1 500	230	05,8082	239,67 €
1,1	1,50	3 000	230	05,8083	277,28 €
1,5	2,00	3 000	230	05,8084	307,10 €
0,55	0,75	1 500	400	05,8085	222,21 €
0,75	1,00	1 500	400	05,8086	234,32 €
1,1	1,50	3 000	400	05,8087	268,28 €
1,5	2,00	3 000	400	05,8088	303,43 €
2,2	3,00	3 000	400	05,8089	388,71 €
3,0	4,00	6 500	400	05,8090	504,21 €
4,0	5,50	6 500	400	05,8091	580,39 €
5,5	7,50	6 500	400	05,8092	757,82 €
7,5	10,00	6 500	400	05,8093	964,50 €

Nota: Esta tabela pode ser alterada sem aviso prévio, preços sujeitos à taxa de I.v.a. em vigor.

Setúbal, 01 de Janeiro de 2018.



Hidrosado, Lda.
 Quinta Varzinha, Lote 25
 2900-721 Setúbal
 Telefone: 265537550
 Fax: 265537551
 Mail: geral@hidrosado.pt
 Site: www.hidrosado.pt

Eletrobombas

Dreno-pumps

Grupos eletrobombas Drenagem - Águas Pluviais

Utilizações: As eletrobombas são particularmente indicadas para drenagem de águas pouco carregadas, com ou sem corpos em suspensão. Ideal para caves, garagens e outros locais inundados. Eletrobomba equipada com interruptor de nível e cabo 10 mts.



Código	Mod.	Ø	Kw	HP	m³/h	0,0	1,2	2,4	3,6	4,2	4,8	5,4	6,0				Volts	Preço
05,3030	WA 350	1.½"	0,35	0,45	H (m)	7,0	6,5	5,5	4,5	3,5	2,5	1,5	1,0	-	-	-	230	70,00 €

Grupos eletrobombas Drenagem - Águas sujas

Utilizações: As eletrobombas são particularmente indicadas para drenagem de águas pouco carregadas, com sólidos em suspensão até 35mm. Ideal para caves, garagens e outros locais inundados. Eletrobomba equipada com interruptor de nível e cabo 10 mts.



Código	Mod.	Ø	Kw	HP	m³/h	0,0	1,2	2,4	3,6	4,8	6,0	7,2	8,4	9,6	10,8	12,0	Volts	Preço
05,3031	WB 400	1.½"	0,4	0,50	H (m)	5,0	4,4	4,0	3,5	2,7	1,0	0,4	-	-	-	-	230	75,00 €
05,3032	WB 750	1.½"	0,75	1,00		8,0	7,8	7,5	7,0	6,5	5,8	4,8	4,0	3,0	2,0	1,0	230	95,00 €

Grupos eletrobombas Drenagem - Águas Pluviais

Utilizações: As eletrobombas são particularmente indicadas para drenagem de águas pouco carregadas, com sólidos em suspensão até 5mm. Ideal para caves, garagens e outros locais inundados. Eletrobomba equipada com interruptor automático.



Código	Mod.	Ø	Kw	HP	m³/h	0,0	1,2	2,4	3,6	4,8	6,0	7,2	8,4	9,6	10,8	12,0	Volts	Preço
05,3034	EQS 550	1.½"	0,55	0,75	H (m)	8,0	7,7	7,2	6,7	6,1	5,6	4,9	3,9	2,3	1,0	-	230	122,40 €

Grupos eletrobombas Drenagem - Águas Pluviais

Utilizações: As eletrobombas são particularmente indicadas para drenagem de águas pouco carregadas, com sólidos em suspensão até 5mm. Ideal para caves, garagens e outros locais inundados. Eletrobomba equipada com interruptor de nível e cabo 10 mts.



Código	Mod.	Ø	Kw	HP	m³/h	0,0	1,2	2,4	3,6	4,8	6,0	7,2	8,4	9,6	11,4		Volts	Preço
05,3035	XKS 750S	1.½"	0,75	1,00	H (m)	8,5	8,0	7,5	7,0	6,0	5,0	4,0	3,0	2,0	1,0	-	230	123,00 €

Grupos eletrobombas Drenagem - Águas sujas

Utilizações: As eletrobombas são particularmente indicadas para drenagem de águas pouco carregadas, com sólidos em suspensão até 35mm. Ideal para caves, garagens e outros locais inundados. Eletrobomba equipada com interruptor de nível e cabo 10 mts.



Código	Mod.	Ø	Kw	HP	m³/h	0,0	2,4	4,8	7,2	9,6	12,0	13,2	15,6				Volts	Preço
05,3036	XKS 750SW	1.½"	0,75	1,00	H (m)	8,0	7,5	7,0	6,0	4,5	2,5	1,0	-	-	-	-	230	148,00 €

Grupos eletrobombas Drenagem - Águas Residuais

Utilizações: Eletrobomba submersível potente para drenagem e evacuação de águas carregadas, com sólidos em suspensão até 40mm. Ideal para águas sujas. Eletrobomba equipada com interruptor de nível e cabo 10 mts.



Código	Mod.	Ø	Kw	HP	m³/h	0,0	2,4	4,8	7,2	9,6	12,0	14,4	16,8	19,2	21,6	24,0	Volts	Preço
05,3033	Dirty 1300	2"	1,3	1,75	H (m)	11,0	10,7	10,2	9,5	8,7	8,0	7,0	6,0	4,5	3,0	1,0	230	140,00 €

Nota: Esta tabela pode ser alterada sem aviso prévio, preços sujeitos à taxa de I.v.a. em vigor.
 Setúbal, 01 de Janeiro de 2018.



Hidrosado, Lda.

Quinta Varzinha, Lote 25

2900-721 Setúbal

Telefone: 265537550

Fax: 265537551

Mail: geral@hidrosado.pt

Site: www.hidrosado.pt

Eletrobombas Águas Residuais



Águas Residuais - Vortex



Código	Mod.	Ø	Kw	HP	m3/h L/mim	0,6	3,0	4,8	6,0	7,2	9,0	10,8	12,0	15,0	Volts	Preço
						0	50	80	100	120	150	180	200	250		
05,3010	VTXS 35G	1.¼"	0,28	0,36	H (m)	6,9	6,5	5,6	4,9	4,1	3,2	2,2	1,9		230	165,95 €
05,3011	VTXS 50G	1.¼"	0,37	0,50	H (m)	8	7,8	7,2	7,0	6,5	5,8	3,9	3,2	0,8	230	171,00 €

Código	Mod.	Ø	Kw	HP	m3/h L/mim	1,5	3,0	6,0	12,0	18,0	21,0	24,0	27,0	30,0	Volts	Preço
						25	50	100	200	300	350	400	450	500		
05,3017	VTX 750	2"	0,75	1,00	H (m)	10,5	10	9	7,5	5,5	3				230	251,20 €

Turbina Vortex para Águas Sujas - Fossas



Código	Designação	H.P.	Volts	Asp. Saída	L/M	H.M.T.	Preço
05,3001	TERMAR - WQD 5-15-0.75 F	1,00	230	2"	268-30	5-15	196,50 €



Para Águas Sujas - Fossas - ALANOL

05,6020	AM-1	1,5	230	1.½"	266,7-133,3	9-25	536,60 €
05,6021	AT-1	1,5	400	1.½"	266,7-133,3	9-25	535,40 €
05,6009	AM-L	1,5	230	1.½"	450-83	2-19	655,00 €
05,6010	AT-L	1,5	400	1.½"	450-83	2-19	646,95 €
05,6011	AT-L	3,0	400	2"	534-83	2-20	759,10 €
05,6025	AT-L	4,0	400	2.½"	583,3-83,3	5-21	980,90 €
05,6015	AM-T C/Triturador	1,5	230	1.½"	400-17	2-17	708,65 €
05,6026	AM-T C/Triturador com bóia	1,5	230	1.½"	400-17	2-17	751,50 €
05,6016	AT-T C/Triturador	1,5	400	1.½"	400-17	2-17	697,10 €



Código	Designação	H.P.	Volts	Asp. Saída	m³/h	H.M.T.	Preço
96280968	Unilift CC 7 A1	0,34	230	1.¼"	5,0	5,2	304,55 €
96280970	Unilift CC 9 A1	1,05	230	1.¼"	13,0	9,5	394,55 €
011H1600	Unilift KP 150 A1	0,40	230	1.¼"	7,2	5,2	395,70 €
012H1600	Unilift KP 250 A1	0,50	230	1.¼"	9,0	7,4	475,30 €
96004562	Unilift AP 35B.50.06.A1	1,50	230	2"	16	10,6	693,30 €
96004574	Unilift AP 35B.50.08.A1	1,50	230	2"	24	10,9	819,00 €
97775315	Sololift2 WC-3	-	230	32-50	WC + WB + S + B		686,40 €

Nota: Esta tabela pode ser alterada sem aviso prévio, preços sujeitos à taxa de I.v.a. em vigor.

Setúbal, 01 de Janeiro de 2018.

Pág.: 21



Hidrosado, Lda.
 Quinta Varzinha, Lote 25
 2900-721 Setúbal
 Telefone: 265537550
 Fax: 265537551
 Mail: geral@hidrosado.pt
 Site: www.hidrosado.pt

Eletrobombas



Grupos eletrobombas Águas Pluviais - Dreno

Utilizações: As electrobombas "Dreno" são particularmente indicadas para captação e drenagem de águas pluviais, com ou sem corpos em suspensão.

Código	Mod.	Ø	Kw	HP	H (m)	0	2	4	6	8	10	12		Volts	Preço
05,6040	R 35.60	1.½"	0,6	0,80	m³/h	13,90	12,40	10,70	8,90	7,00	4,90	2,60		230	210,47 €
05,6041						19,40	17,50	15,40	13,10	10,60	7,70	4,40	400	193,14 €	
05,6042	R 40.75	1.½"	0,75	1,00										230	222,85 €
05,6043														400	211,71 €
05,6095	R 40.80	1.½"	0,80	1,10										230	272,38 €
05,6096														400	258,76 €
05,6044	R 50.110	2"	1,1	1,50										230	325,61 €
05,6045														400	313,23 €

Grupos eletrobombas Águas Residuais - Vortex

Utilizações: As electrobombas "Vortex N" são particularmente indicadas para captação e drenagem de águas pluviais pesadas, com ou sem corpos em suspensão.

Código	Mod.	Ø	Kw	HP	H (m)	0	2	4	6	8	10	12	14		Volts	Preço
05,6046	N 35.60	1.½"	0,6	0,80	m³/h	15,30	12,20	9,30	6,60	4,00	1,50				230	204,28 €
05,6047														400	186,95 €	
05,6048	N 40.37	1.½"	0,37	0,50										230	194,38 €	
05,6049														400	182,00 €	
05,6050	N 40.75	1.½"	0,75	1,00										230	215,42 €	
05,6051														400	205,52 €	
05,6052	N 50.110	2"	1,1	1,50										230	314,47 €	
05,6053														400	303,33 €	
05,6054	N 50.150	2"	1,5	2,00										230	344,19 €	
05,6055														400	325,61 €	
05,6056	F 35.60	1.½"	0,6	0,80		m³/h	14,80	13,00	10,90	8,60	6,10	3,10			230	234,00 €
05,6057															400	316,66 €
05,6058	F 40.75	1.½"	0,75	1,00										230	245,14 €	
05,6059														400	236,47 €	
05,6060	F 50.75	2"	0,75	1,00										230	299,61 €	
05,6061														400	288,47 €	
05,6062	F 50.110	2"	1,1	1,50										230	376,38 €	
05,6063														400	365,23 €	
05,6064	F 50.150	2"	1,5	2,00										230	406,09 €	
05,6065														400	388,76 €	
05,6066	F 65.150	2.½"	1,5	2,00										230	470,47 €	
05,6067														400	469,23 €	
05,6068	F 65.220	2.½"	2,2	2,00									400	538,57 €		
05,6070	SF 80.220 s/boia	3"	2,2	3,00	m³/h	63,40	54,70	45,20	35,40	25,00	13,20	0,30		400	689,61 €	
05,6071	SF 80.300 s/boia	3"	3	4,00											400	794,85 €
05,6072	SV 50.75 c/flange + boia	DN50	0,75	1,00											230	702,00 €
05,6073															400	702,00 €
05,6074	SV 50.150 c/flange + boia	DN50	1,5	2,00											230	823,33 €
05,6075															400	823,33 €
05,6076	SV 65.300 c/flange	DN65	3,0	4,00											400	973,14 €
05,6077	SV4P 80.220 4 polos 1450rpm	3"	2,2	3,00											400	1.998,28 €

Nota: Esta tabela pode ser alterada sem aviso prévio, preços sujeitos à taxa de I.v.a. em vigor.

Setúbal, 01 de Janeiro de 2018.

Pág.: 22

Eletrobombas



Grupos Eletrobombas " Águas Residuais " - Monocanal

Utilizações: As electrobombas "Monocanal" são particularmente indicadas para tratamento de águas residuais, águas de processos industriais e esgotos brutos não tratados em aplicações municipais, públicas e industriais. O impulsor monocanal permite a passagem de sólidos na bomba MC50 até 50mm e na bomba MC65 até 65mm, diminuindo o risco de entupimento. Ideais para instalação com sistema de acoplamento e guias.



Código	Mod.	Ø	Kw	HP	H (m)	0	2	4	6	8	10	12	14	16	18	20	Volts	Preço	
05,6080	MC 50.220 C/flange	DN50	2,2	3,00	m ³ /h	60,60	55,60	50,10	44,10	37,50	30,30	21,60	11,70				400	926,09 €	
05,6081	MC 65.300 C/flange	DN65	3	4,00		68,10	62,70	56,70	50,40	44,10	37,20	29,70	22,20	13,50	4,20			400	1.058,57 €
05,6082	MC4P 80.220 4 polos 1450rpm	DN65	3	4,00		74,20	68,80	62,60	55,90	48,40	40,10	30,70	18,40	0,40				400	2.086,19 €

Grupos Eletrobombas " Águas Residuais " - Grinder

Utilizações: As electrobombas "Grinder" são particularmente indicadas para captação e drenagem de águas pluviais pesadas, com sólido e fibras. O sistema de trituração assegura que todos os sólidos e fibras são triturados em pequenos pedaços a fim de passas na turbina e nos tubos. Ideais para instalação com sistema de acoplamento.



Código	Mod.	Ø	Kw	HP	H (m)	0	3	6	9	12	15	18	20	25	27	30	Volts	Preço	
05,6083	SGR 40.120	1.½"	1,2	1,60	m ³ /h	16,50	15,10	13,30	11,40	9,30	4,50	3,90	1,50	0				400	641,33 €
05,6084	SGR 40.150.1A	1.½"	1,5	2,00		16,50	15,10	13,30	11,40	9,30	4,50	3,90	1,50	0				230	812,19 €
05,6086	SGR 50.220	2"	2,2	3,00		32,20	18,00	16,60	15,50	14,50	12,90	11,30	10,00	6,70	4,80	0		400	934,76 €

Kit descida*



Código	Mod.	A Ø	B	C	D	E	F	G	H	I	Preço
05,6090	Kit descida DN50	2"	235	140	190	100	63,5	130	160	135	101,47 €
05,6091	Kit descida DN65	2.½"	285	166	220	119	68	150	180	165	139,83 €
05,6092	Kit descida DN80	3"	298	174	229	119	68	180	210	175	186,87 €

* Nota: Barras de descida não incluídas.

Nota: Esta tabela pode ser alterada sem aviso prévio, preços sujeitos à taxa de I.v.a. em vigor.
Setúbal, 01 de Janeiro de 2018.



Hidrosado, Lda.
 Quinta Varzinha, Lote 25
 2900-721 Setúbal
 Telefone: 265537550
 Fax: 265537551
 Mail: geral@hidrosado.pt
 Site: www.hidrosado.pt

Eletrobombas Águas Residuais



Grupos Eletrobombas " Águas Residuais "

Código	Designação	H.P.	Volts	Asp.	L/M	H.M.T.	Preço
				Saida			

Para Águas Limpas - ITT Lowara



107540000	DOC 3 - Turbina monocanal	0,34	230	1.¼"	135-25	2-6,3	193,95 €
107540250	DOC 3/A GT	0,34	230	1.¼"	135-25	2-6,3	216,45 €
107540020	DOC 7 - Turbina monocanal	0,75	230	1.¼"	225-50	10,4-3,7	241,10 €
107540030	DOC 7 VX - Turbina Vortex	0,75	230	1.¼"	175-50	6,4-3,1	248,60 €
107540050	DOC 7 T - Turbina Vortex	0,75	400	1.¼"	225-50	10,4-3,7	207,85 €
107540060	DOC 7 VXT - Turbina Vortex	0,75	400	1.¼"	175-50	6,4-3,1	216,45 €
107540260	DOC 7/A GT	0,75	230	1.¼"	225-50	10,4-3,7	261,45 €
107540270	DOC 7 VX/A GT	0,75	230	1.¼"	175-50	6,4-3,1	271,10 €
107680010	DIWA 05/B	0,55	230	1.½"	250-100	3,8-8,6	500,35 €
107680020	DIWA 07/B	0,75	230	1.½"	325-100	3,9-11,2	545,35 €
107680030	DIWA 11/B	1,1	230	1.½"	375-150	4-11,9	626,80 €



Para Águas Sujas - Lowara

107670110	DOMO 7 VX- Turbina Vortex nylon	0,75	230	1.½"	260-80	2-7,1	349,25 €
107670320	DOMO S7VX	0,75	230	1.½"	260-80	2-7,1	366,40 €
107670120	DOMO 10 VX	1,00	230	2"	400-100	3,1-7,1	455,35 €
107670130	DOMO 15 VX	1,50	230	2"	450-100	3,7-8,6	588,20 €
107670070	DOMO 10 T	1,00	400	2"	500-100	3,2-8,5	409,25 €
107670080	DOMO 15 T	1,50	400	2"	600-150	3,6-10,2	487,45 €
107670090	DOMO 20 T	2,00	400	2"	670-200	4,2-11,7	563,55 €
107679010	DOMO GRI 11 - c/Triturador + Boia	1,50	230	1"	110-15	9,5-25	693,15 €
107679005	DOMO GRI 11T - c/Triturador	1,50	400	1"	110-15	9,5-25	654,60 €

Nota: Esta tabela pode ser alterada sem aviso prévio, preços sujeitos à taxa de I.v.a. em vigor.
 Setúbal, 01 de Janeiro de 2018.



Hidrosado, Lda.
 Quinta Varzinha, Lote 25
 2900-721 Setúbal
 Telefone: 265537550
 Fax: 265537551
 Mail: geral@hidrosado.pt
 Site: www.hidrosado.pt

Bombas Ornamentais para lagos



Código	Artigo	Preço
--------	--------	-------

Eletrobombas decorativas para lagos

24.1006	Bomba p/lago - Ultra Zero - 3000 L/H 230V - 3,1mt 80W	96,80 €
---------	--	---------



Eletrobomba de Drenagem Modelo Master DW

Equipada 10 mts cabo eléctrico e sistema anti-bloqueio e protecção contra falta de água

24.1025	Bomba p/lago - Master DW 4000 - 2.75 Hmt -3700 L/H	99,00 €
24.1026	Bomba p/lago - Master DW 5500 - 4.00 Hmt -5400 L/H	149,00 €
24.1027	Bomba p/lago - Master DW 8000 - 6.00 Hmt -8000 L/H	219,00 €
24.1028	Bomba p/lago - Master DW 10500 - 9.50 Hmt -10500 L/H	322,85 €



24.1030	Bomba p/lago - Syncrapond 0,5 - 700 L/H - 1.2 hmt	53,00 €
24.1031	Bomba p/lago - Syncrapond 1,0 - 950 L/H - 1.5 hmt	62,80 €
24.1032	Bomba p/lago - Syncrapond 1,5 - 1350 L/H - 1.8 hmt	69,00 €
24.1033	Bomba p/lago - Syncrapond 2,0 - 2150 L/H - 2.0 hmt	91,00 €
24.1034	Bomba p/lago - Syncrapond 3,0 - 2700 L/H - 3.0 hmt	108,00 €
24.1035	Bomba p/lago - Syncrapond 4,0 - 3500 L/H - 3.7 hmt	128,00 €
24.1036	Bomba p/lago - Syncrapond 5,0 - 5000 L/H - 3.8 hmt	138,80 €



Kit's Lagos e Filtros Happy Pond

24.1050	Kit Happy Pond 1 - 120 Lts c/Syncrapond 0.5	133,65 €
24.1051	Kit Happy Pond 2 - 275 Lts c/Syncrapond 1.5	243,20 €
24.1052	Kit Happy Pond 3 - 400 Lts c/Syncrapond 2.5	287,40 €
24.1053	Kit Happy Pond 4 - 550 Lts c/Syncrapond 3.0	443,40 €
24.1054	Kit Happy Pond 5 - 680 Lts c/Syncrapond 3.0	465,60 €



Filtros para lagos modelo Green Reset

Equipados com lâmpadas UVC e válvula backwash

24.1060	Filtro Green Reset 25 com lâmpada UV 10W	293,80 €
24.1061	Filtro Green Reset 40 com lâmpada UV 20W	351,95 €
24.1062	Filtro Green Reset 60 com lâmpada UV 2 x 20W	465,75 €
24.1063	Filtro Green Reset 100 com lâmpada UV 2 x 25W	554,80 €



Projectores equipados com 3 lentes coloridas e 10 mts de cabo eléctrico

24.1001	Projector Halley 12V - 20W s/transformador	61,00 €
24.1002	Projector Halley 12V - 20W c/transformador	91,00 €



Nota: Esta tabela pode ser alterada sem aviso prévio, preços sujeitos à taxa de I.v.a. em vigor.
 Setúbal, 01 de Janeiro de 2018.



Eletrobombas Matra



Código	Mod.	Ø	Kw	HP	m3/h L/mim	0,6	1,2	1,8	2,4	3					Volts	Preço
						10	20	30	40	50						
04,1017	CM6/1 -CP45	1"x1"	0,37	0,50	H (m)	30	21	13	5,0						230	80,50 €
04,1018	CM6/4 -CP75	1"x1"	0,74	1,00		56	48	39	31	16					230	116,00 €



Código	Mod.	Ø	Kw	HP	m3/h L/mim	1,2	1,8	2,4	3	3,6	4,8	6	7,2			Volts	Preço	
						20	30	40	50	60	80	100	120					
04,1002	Jet100 - T	1"x1"	0,74	1,00	H (m)											230	165,67 €	
04,1007	Jet100 - TT					42	37	32	27	10							400	165,67 €
04,1005	Jet100 - T/N																	230



Código	Mod.	Ø	Kw	HP	m3/h L/mim	1,2	1,8	2,4	3	3,6	4,8	6	7,2			Volts	Preço
						20	30	40	50	60	80	100	120				
04,1003	Jet 150 - TE	1.½"x1"	1,1	1,50	H (m)	44,9	41,8	39,6	37,0	34,7	30,4	26,3	21,8			230	413,70 €
04,1004	Jet 150 - TET																
04,1008	Jet 200 - TF	1.½"x1"	1,65	2,20	H (m)	52,4	49,8	46,7	44,0	42,0	38,0	34,0	29,3			230	419,00 €
04,1009	Jet 200 - TFT																



Código	Mod.	Ø	Kw	HP	m3/h L/mim	4,8	7,2	9,6	12	14	17	18			Volts	Preço
						80	120	160	200	240	280	300				
04,1038	CR 100	1.½"x1.¼"	0,74	1,00	H (m)	19,2	18,5	17,3	15,5	13,5	10,5	7			230	183,55 €
04,1040	CRT 100															



Código	Mod.	Ø	Kw	HP	m3/h L/mim	1,8	2,7	3,6	4,8	6,0	7,2	9,0	10,8	12,0			Volts	Preço
						30	45	60	80	100	120	150	180	200				
04,1028	MB 150	1.½"x1.¼"	1,1	1,50	H (m)	39,0	38,5	37,5	36,5	34,0	31,0	25,0					230	305,92 €
04,1030	MBT 150																	
04,1053	MB 200	1.½"x1.¼"	1,5	2,00	H (m)	42,5	42,0	41,5	40,0	37,5	35,0	29,0					230	315,00 €
04,1055	MBT 200																	
04,1049	MBT 300	1.½"x1.¼"	2,2	3,00	H (m)	48,0	47,5	47,1	46,5	46,0	44,0	38,5	31,5	25,0		400	325,00 €	



Código	Mod.	Ø	Kw	HP	m3/h L/mim	6,0	9,0	12,0	18,0	24	30					Volts	Preço
						100	150	200	300	400	500						
04,1270	ES 150	2"x2"	1,1	1,50	H (m)	24,5	23,5	22,5	18,5	12,5	4,0					230	313,57 €
04,2071	EST 150																
04,2091	ES 200	2"x2"	1,5	2,00	H (m)	28,0	26,5	25,0	21,0	15,0	5,5					230	326,73 €
04,2081	EST 200																
04,2082	EST 300	2"x2"	2,2	3,00	H (m)	33,5	32,5	31,5	28,0	22,5	13,5					400	346,31 €

Nota: Esta tabela pode ser alterada sem aviso prévio, preços sujeitos à taxa de I.v.a. em vigor.
 Setúbal, 01 de Janeiro de 2018.



Hidrosado, Lda.

Quinta Varzinha, Lote 25

2900-721 Setúbal

Telefone: 265537550

Fax: 265537551

Mail: geral@hidrosado.pt

Site: www.hidrosado.pt

Eletrobombas



Eletrobombas Matra

Código	Mod.	Ø	Kw	HP	m3/h L/mim	1,2	3,0	4,5	6,0	7,5	9,0	10,5	12,0	Volts	Preço	
						20	50	75	100	125	150	175	200			
04,1043	CB 100 - 2CD67	1" x 1"	0,74	1,00	H (m)	39,4	32,5	23						230	232,54 €	
04,1047	CB 100 - 2CD67t								400	232,54 €						
04,1029	CB 150 - 2CD68	1.¼" x 1"	1,1	1,50		52,0	48,0	44,0	40,0	35,0					230	348,80 €
04,1031	CB 150 - 2CD68t										400	348,80 €				
04,1085	CB 200 - 2CD69	1.¼" x 1"	1,5	2,00		56,0	53,0	49,0	44,0	38,0					230	386,00 €
04,1032	CB 200 - 2CD69t										400	378,20 €				
04,1033	CB 300 - 2CB70t	1.¼" x 1"	2,2	3,00		63,0	59,0	55,0	50,0	43,0	36,0				400	385,00 €
04,1034	CB 400 - 2CB71	1.½" x 1.¼"	3,0	4,00		65,2	63,3	61,0	58,4	55,2	51,5	47,8	44,2		400	688,60 €
04,1035	CB 550 - 2CB72	1.½" x 1.¼"	4,0	5,50		79,1	76,1	74,6	72,0	69,4	66,0	62,4	58,7		400	712,30 €

Código	Mod.	Ø	Kw	HP	m3/h L/mim	12	15	18	24	30	36	42	48	54	60	72	84	96	Volts	Preço	
						200	250	300	400	500	600	700	800	900	1000	1200	1400	1600			
04,1093	CS 150	2" x 2"	0,74	1,00	H (m)	12,2	11,9	11,8	11,0	10,2	9,1	7,7	6,0						230	303,12 €	
04,1042	CST 150													400	303,12 €						
04,1050	CS 200	2" x 2"	1,5	2,00		13,6	13,3	13,1	12,4	11,6	10,6	9,4	7,8	6,0						230	320,83 €
04,1048	CST 200														400	320,83 €					
04,1086	CST 300/3	3" x 3"	2,2	3,00			17,5	17,5	17,2	16,4	15,3	14,2	12,3	9,9	7,5					400	499,20 €
04,1087	CST 400/3	3" x 3"	3,0	4,00			21,5	21,5	21,4	20,6	19,9	18,9	17,7	15,9	13,5	8,3				400	520,00 €
04,1088	CST 450/4	4" x 4"	3,0	4,00						14,3	14,1	13,9	13,4	12,8	12,1	10,3	8,3	6,1		400	576,80 €
04,1095	CST 550/4	4" x 4"	4,0	5,50						17,5	17,3	17,1	16,8	16,3	15,7	14,4	12,2	10,0		400	601,80 €

Código	Mod.	Ø	Kw	HP	m3/h L/mim	9	12	15	18	21	24	27	30	33	36	Volts	Preço													
						150	200	250	300	350	400	450	500	550	600															
04,1059	CM 40/160B	2.½" x 2"	3,0	4,00	H (m)	30,1	30,0	29,6	29,0	28,2	27,1	25,9	24,4	22,8	21,0				400	767,90 €										
04,1060	CM 40/160A	2.½" x 2"	4,0	5,50												35,6	35,5	35,3	35,0	34,2	33,2	32,0	30,6	29,0	27,3				400	796,70 €
04,1061	CM 40/200B	2.½" x 2"	5,5	7,50												47,0	46,8	46,4	45,6	44,5	43,2	41,6	39,9	37,9	35,8				400	1.089,00 €
04,1062	CM 40/200A	2.½" x 2"	7,5	###												58,0	57,9	57,8	57,6	56,9	56,0	54,7	53,0	51,1	48,9				400	1.147,00 €



CB 150/200/300/400/550



CS 150/200/300...



CM 40/160 /200

Nota: Esta tabela pode ser alterada sem aviso prévio, preços sujeitos à taxa de I.v.a. em vigor.

Setúbal, 01 de Janeiro de 2018.



Hidrosado, Lda.

Quinta Varzinha, Lote 25

2900-721 Setúbal

Telefone: 265537550

Fax: 265537551

Mail: geral@hidrosado.pt

Site: www.hidrosado.pt

Eletrobombas



Eletrobombas Matra



Código	Mod.	Ø	Kw	HP	m3/h L/mim	0,6	1,2	1,8	2,4	3	Volts	Preço
						10	20	30	40	50		
04,1074	CM6/1 - CP45 Super Domus	1"x1"	0,37	0,50	H (m)	30	21	13	5,0		230	134,84 €
04,1075	CM6/4 - CP75 Super Domus	1"x1"	0,74	1,00		56	48	39	31	16		230

Código	Mod.	Ø	Kw	HP	m3/h L/mim	1,2	1,8	2,4	3	3,6	4,8	6	Volts	Preço
						20	30	40	50	60	80	100		
04,1073	T - Jet 100 Super domus	1"x1"	0,74	1,00	H (m)	42	37	32	27	10			230	220,00 €
04,1078	TT - Jet100 Super domus	1"x1"	0,74	1,00		42	37	32	27	10			400	220,00 €

Código	Mod.	Ø	Kw	HP	m3/h L/mim	0,6	1,2	1,8	2,4	3	Volts	Preço
						10	20	30	40	50		
04,2075	CM6/1 - CP45 c/auto 24Lts horizontal	1"x1"	0,37	0,50	H (m)	30	21	13	5,0		230	172,72 €
04,2076	CM6/4 - CP75 c/auto 24Lts horizontal	1"x1"	0,74	1,00		56	48	39	31	16		230

Código	Mod.	Ø	Kw	HP	m3/h L/mim	1,2	2,7	3,6	4,5	5,4	6,3	Volts	Preço
						20	45	60	75	90	105		
04,1079	TE - Jet100 c/auto 24Lts horizontal	1"x1"	0,74	1,00	H (m)	42	37	32	27	10		230	257,89 €

Eletrobombas c/Brio 2000 - Matra



Código	Mod.	Ø	Kw	HP	m3/h L/mim	0,6	1,2	1,8	2,4	3	Volts	Preço
						10	20	30	40	50		
04,3001	CM6/1 - CP45 c/brio 2000	1"x1"	0,37	0,50	H (m)	30	21	13	5,0		230	145,28 €
04,3002	CM6/4 - CP75 c/brio 2000	1"x1"	0,74	1,00		56	48	39	31	16		230

Código	Mod.	Ø	Kw	HP	m3/h L/mim	1,2	1,8	2,4	3	3,6	4,8	6	Volts	Preço
						20	30	40	50	60	80	100		
04,3004	TE - Jet100 c/brio 2000	1"x1"	0,74	1,00	H (m)	42	37	32	27	10			230	230,45 €
04,3014	T/N - Jet100 c/brio 2000	1"x1"	0,75	2,00	H (m)	42	37	32	27	10			230	200,98 €

Nota: Esta tabela pode ser alterada sem aviso prévio, preços sujeitos à taxa de I.v.a. em vigor.

Setúbal, 01 de Janeiro de 2018.

Pág.: 28



Hidrosado, Lda.

Quinta Varzinha, Lote 25

2900-721 Setúbal

Telefone: 265537550

Fax: 265537551

Mail: geral@hidrosado.pt

Site: www.hidrosado.pt

Eletrobombas

Eletrobombas



Código	Mod.	Ø	Kw	HP	m3/h	0,6	1,2	1,8	2,4	3					Volts	Preço	
					L/mim	10	20	30	40	50							
04,4005	CP 45 = (XKM60/1)	1" x 1"	0,37	0,50	H (m)	30	21	13	5,0						230	68,40 €	
04,4006	CP 75 = (XKM70/1)	1" x 1"	0,60	0,80		56	48	39	31	16					230	111,82 €	
Código	Mod.	Ø	Kw	HP	m3/h	0,6	1,2	1,8	2,4	3	3,6					Volts	Preço
					L/mim	10	20	30	40	50	60						
04,4029	Jet 100 = (XJm100L)	1" x 1"	0,74	1,00	H (m)		42	37	32	27	10				230	152,00 €	
04,4003	Inox 100 = (XJM101C)	1" x 1"	0,74	1,00			38	32	26	15					230	178,00 €	
Código	Mod.	Ø	Kw	HP	m3/h	4	9	10	12	15	30					Volts	Preço
					L/mim	66	150	166	200	250	500						
04,4004	CR 100 = (XGM/1A)	1.½"x1.½"	0,74	1,00	H (m)	19	19	17	16	14					230	182,40 €	
04,4026	XHM/5BM	2" x 2"	1,1	1,50			21	20	19	18	8				230	314,80 €	
Código	Mod.	Ø	Kw	HP	m3/h	6,0	9,0	12,0	18,0	24	30					Volts	Preço
					L/mim	100	150	200	300	400	500						
04,4022	ES 150 = (XSM60)	2" x 2"	1,1	1,50	H (m)	24,5	23,5	22,5	18,5	12,5	4,0				230	263,80 €	
04,4023	ES 200 = (XSM70)	2" x 2"	1,5	2,00			28,0	26,5	25,0	21,0	15,0	5,5			230	309,40 €	
Código	Mod.	Ø	Kw	HP	m3/h	1,2	3,0	4,5	6,0	7,5	9,0					Volts	Preço
					L/mim	20	50	75	100	125	150						
04,4008	CB 200 = (2XCm25/160B)	1.½" x 1"	1,5	2,00	H (m)	56,0	53,0	49,0	44,0	38,0					230	366,90 €	
04,4007	CB 300 = (2XCm25/160A)	1.½" x 1"	2,2	3,00			63,0	59,0	55,0	50,0	43,0	36,0			400	489,65 €	

Nota: Esta tabela pode ser alterada sem aviso prévio, preços sujeitos à taxa de I.v.a. em vigor.

Setúbal, 01 de Janeiro de 2018.



Hidrosado, Lda.

Quinta Varzinha, Lote 25

2900-721 Setúbal

Telefone: 265537550

Fax: 265537551

Mail: geral@hidrosado.pt

Site: www.hidrosado.pt

Eletrobombas



Grupos hidropneumáticos c/autoclave 24Lts Leo

Código	Mod.	Ø	Kw	HP	m3/h L/mim	0,6	1,2	1,8	2,4	3	Volts	Preço
						10	20	30	40	50		
04,4012	CP 45 = (XKM60/1)	1"x1"	0,37	0,50	H (m)	30	21	13	5,0		230	122,74 €
04,4013	CP 75 = (XKM70/1)	1"x1"	0,74	1,00		56	48	39	31	16	230	166,16 €

Código	Mod.	Ø	Kw	HP	m3/h L/mim	1,2	1,8	2,4	3	3,6	Volts	Preço
						20	30	40	50	60		
04,4028	Jet 100 = (XJm100L)	1"x1"	0,74	1,00	H (m)	42	37	32	27	10	230	206,34 €

Código	Mod.	Ø	Kw	HP	m3/h L/mim	1,2	1,8	2,4	3	3,6	Volts	Preço
						20	30	40	50	60		
04,4024	Inox 100 = (XJM100C)	1"x1"	0,74	1,00	H (m)	38	32	26	15		230	195,83 €

Código	Mod.	Ø	Kw	HP	m3/h L/mim	0,6	1,2	1,8	2,4	3	Volts	Preço
						10	20	30	40	50		
04,4015	XJM / 250 A	1"x1"	0,6	0,80	H (m)	35	31	22	10		230	224,74 €
04,4016	XJM / 375 A	1"x1"	0,74	1,00		42	37	32	27	10	230	230,00 €

Grupos hidropneumáticos c/autoclave 24Lts - Horizontal Leo

Código	Mod.	Ø	Kw	HP	m3/h L/mim	1,2	1,8	2,4	3	3,6	Volts	Preço
						20	30	40	50	60		
04,4100	Jet 100 = (XJm100 L)	1"x1"	0,74	1,00	H (m)	42	37	32	27	10	230	222,45 €

Electrobombas LEO c /Brio2000

Código	Mod.	Ø	Kw	HP	m3/h L/mim	1,2	1,8	2,4	3	3,6	Volts	Preço
						20	30	40	50			
04,4040	CP 45 = (XKM60/1)	1"x1"	0,37	0,50	H (m)	21	13	5,0			230	146,62 €
04,4041	CP 75 = (XKM70/1)	1"x1"	0,60	0,80		48	39	31	16		230	190,00 €
04,4043	Jet 100 = (XJm100 L)	1.½"x1.½"	0,74	1,00		42	37	32	27	10	230	230,22 €

Nota: Esta tabela pode ser alterada sem aviso prévio, preços sujeitos à taxa de I.v.a. em vigor.

Setúbal, 01 de Janeiro de 2018.

Pág.: 30



Hidrosado, Lda.
 Quinta Varzinha, Lote 25
 2900-721 Setúbal
 Telefone: 265537550
 Fax: 265537551
 Mail: geral@hidrosado.pt
 Site: www.hidrosado.pt

Eletrobombas

Eletrobomba Auto-ferrante



Código	Mod.	Ø	Kw	HP	m³/h								Volts	Preço
					0	1,2	1,8	2,4	3,0	3,6				
04,4018	I-Jet 1200	1" x 1"	1,1	1,50	45	34	29	24	17	2			230	188,00 €
04,4048	JPG 1000	1" x 1"	1,0	1,50	44	42	38	32	25	15			230	102,40 €

Eletrobombas



Código	Mod.	Ø	Kw	HP	m³/h								Volts	Preço
					0	0,3	0,9	1,2	1,5	1,8	2,1	2,7		
04,4045	QB 60	1" x 1"	0,37	0,50	35	30	20	15	11	6,5	3		230	48,85 €
04,4046	QB 70	1" x 1"	0,55	0,75	55	49	37	30	23	17	12	5	230	85,77 €



Código	Mod.	Ø	Kw	HP	m³/h						Volts	Preço	
					0	0,6	1,2	1,8	2,4	3			
04,4050	HJ 10m	1" x 1"	0,75	1,00	43	38	32	27	24	21		230	122,68 €



Grupo Hidropneumático c/autoclave de 24 Lts

04,4085	HJ 10m - Super Domus	1" x 1"	0,76	2,00	H (m)	43	38	32	27	24	21		230	166,50 €
---------	----------------------	---------	------	------	---------	----	----	----	----	----	----	--	-----	----------

Nota: Esta tabela pode ser alterada sem aviso prévio, preços sujeitos à taxa de I.v.a. em vigor.

Setúbal, 01 de Janeiro de 2018.



Hidrosado, Lda.

Quinta Varzinha, Lote 25

2900-721 Setúbal

Telefone: 265537550

Fax: 265537551

Mail: geral@hidrosado.pt

Site: www.hidrosado.pt

Eletrobombas



Eletrobombas superficie multicelulares

Utilizações: Elevadas prestações e baixo nível de ruído. Indicadas para água limpa á temperatura máx. de 35°C, para uso doméstico ou industrial (pressurização, rega, etc). Corpo de bomba em ferro fundido. Camisa externa, veio e turbinas em aço inox. Difusores em noryl reforçado.



Código	Mod.	Ø	Kw	HP	H (m)	0	0,6	1,2	1,8	2,4	3,0	4,5	5,7	9,0	10,5	Volts	Preço	
04.4200	CMH 24.80	1" x 1"	0,8	1,10	m³/h	52	51	48	46	43	39	27	15			230	210,50 €	
04.4201						67	65,5	63	59	56	51	39	24			400	210,50 €	
04.4202	CMH 25.120	1" x 1"	1,2	1,60		78	76,5	74	71	67	62	46	29			230	222,85 €	
04.4203						89	86	84	80	75	59	39			400	222,85 €		
04.4204	CMH 26.120	1" x 1"	1,2	1,60		91	89	86	84	80	75	59	39			230	240,20 €	
04.4205						91	89	86	84	80	75	59	39			400	240,20 €	
04.4206	CMH 27.150	1" x 1"	1,5	2,00	50	49,5	49	48,5	48	47	43	39	20	7,5		230	273,65 €	
04.4207					66	65,5	65	64	63	62	57	52	28	11		400	273,65 €	
04.4210	CMH 34.110	1.¼" x 1.¼"	1,1	1,50	m³/h	50	49,5	49	48,5	48	47	43	39	20	7,5		230	303,35 €
04.4211						66	65,5	65	64	63	62	57	52	28	11		400	303,35 €
04.4212	CMH 35.150	1.¼" x 1.¼"	1,5	2,00		50	49,5	49	48,5	48	47	43	39	20	7,5		230	350,40 €
04.4213						66	65,5	65	64	63	62	57	52	28	11		400	350,40 €



Código	Mod.	Ø	Kw	HP	H (m)	0	10,0	15,0	20,0	25,0	30,0	35,0	40,0	45,0	50,0	55,0	Volts	Preço
04.4215	JET 1000	1" x 1"	0,8	1,00	m³/h	3,6	3,2	2,9	2,6	2,4	2,1	1,7	1,4	1	0,5	0	230	208,00 €
04.4216						3,6	3,2	2,9	2,6	2,4	2,1	1,7	1,4	1	0,5	0	400	208,00 €

Eletrobombas superficie Monobloco

Utilizações: Bombas económicas para aplicações domésticas ou agricultura. Indicadas para água limpa não abrasiva. Temperatura máx. da água: 35°C.



Código	Mod.	Ø	Kw	HP	H (m)	0	5,0	10,0	15,0	20,0	22,0	24,0	26,0	28,0	30,0	35,0	40,0	Volts	Preço	
04.4220	MB35 30.75	1.¼" x 1.¼"	0,75	1,00	m³/h	10	8,6	7,2	5,7	4,0	3,3	2,5	1,7	0,9	0			230	220,40 €	
04.4221						14	12,1	10,1	7,9	5,6	4,6	3,5	2,4	1,3	0			400	227,80 €	
04.4222	MB35 30.110	1.¼" x 1.¼"	1,1	1,50		14	12,1	10,1	7,9	5,6	4,6	3,5	2,4	1,3	0			230	229,05 €	
04.4223						16	13,5	10,7	7,2	2,6	0							400	232,80 €	
04.4224	MB40 22.75	1.½" x 1.½"	0,75	1,00		16	13,5	10,7	7,2	2,6	0								230	231,55 €
04.4225						17	14,9	12,6	10,1	7,3	6	4,7	3,4	1,7	0			400	229,95 €	
04.4226	MB40 30.110	1.½" x 1.½"	1,1	1,50	17	14,9	12,6	10,1	7,3	6	4,7	3,4	1,7	0				230	238,95 €	
04.4227					18	16,2	14,4	12,3	10	9	7,9	6,8	5,6	4,2	0		400	235,25 €		
04.4228	MB40 35.220	1.½" x 1.½"	2,2	3,00	18	16,2	14,4	12,3	10	9	7,9	6,8	5,6	4,2	0			400	388,80 €	
04.4229					18	16,3	14,6	12,7	10,7	9,9	9	8,1	7,1	6,1	3,3	0	400	401,15 €		

Código	Mod.	Ø	Kw	HP	H (m)	0	10,0	15,0	20,0	22,0	27,0	30,0	35,0	40,0	45,0	50,0	Volts	Preço	
04.4240	MB50 22.150	2" x 2"	1,5	2,00	m³/h	26	16,4	10,5	3,5	0,0							400	289,75 €	
04.4241						26	18,4	14	8,9	6,7	0,0							400	371,45 €
04.4242	MB50 50.400	2" x 2"	4,0	5,50		30	25,5	22,9	20,1	19	16,2	14,4	11,2	7,8	4,2	0		400	668,60 €
04.4243						40	29,8	24	17,2	14,4	6	0						400	674,80 €
04.4244	MB65 35.550	2.½" x 2.½"	5,5	7,50		40	31,4	26,6	21,2	19	12,6	8,4	0,0					400	921,15 €
04.4245						60	47,1	40	31,8	28,2	18,6	13	0,0					400	921,15 €

Kit's Hidropneumáticos

O Kit é composto por:

Eletrobomba. Autoclave 24L Elbi (Horizontal). Pressostato + Manómetro + Record 5 vias.

Cabo de alimentação c/ ficha Schuko (2,5m) Canhão M-F + Tubo Flexível 1" 60cm c/ curva.

Código	Mod.	Ø	Kw	HP	H (m)	H Máx (mts)	Q Máx (m³/h)	Volts	Preço
04.4250	HP CMH 24.80	1" x 1"	0,8	1,10	m³/h	52	6,9	230	351,62 €
04.4251								400	355,35 €
04.4252	HP CMH 25.120	1" x 1"	1,2	1,60		67	7,2	230	362,80 €
04.4253								400	366,50 €
04.4254	HP JET 1000.80	1" x 1"	0,8	1,10		55	3,6	230	315,75 €
04.4255								400	329,35 €



Nota: Esta tabela pode ser alterada sem aviso prévio, preços sujeitos à taxa de I.v.a. em vigor.

Setúbal, 01 de Janeiro de 2018.



Hidrosado, Lda.

Quinta Varzinha, Lote 25

2900-721 Setúbal

Telefone: 265537550

Fax: 265537551

Mail: geral@hidrosado.pt

Site: www.hidrosado.pt

Eletrobombas



Eletrobombas Multicelulares Inox



Código	Mod.	Ø	Kw	HP	m3/h L/mim	1,5	2,0	2,5	3,0	3,2	3,5	4,0	4,5	Volts	Preço
						25,0	33,3	41,6	50,0	53,3	58,3	66,6	75,0		
05,7201	EH 3/4	1.¼" x 1"	0,55	0,75	H (m)	40	38	35	30	29	28	25	20	230	281,10 €
05,7202														400	281,10 €
05,7203	EH 3/5	1.¼" x 1"	0,75	1,0		50	47	45	40	37	35	30	25	230	305,40 €
05,7204														400	305,40 €
05,7205	EH 3/6	1.¼" x 1"	0,9	1,2		60	55	52	48	45	40	35	30	230	347,60 €
05,7206														400	347,60 €
05,7207	EH 3/7	1.¼" x 1"	1,1	1,5		70	65	60	55	50	45	40	35	230	386,90 €
05,7208														400	386,90 €
05,7209	EH 3/9	1.¼" x 1"	1,5	2,0		90	85	80	70	65	60	52	40	230	519,80 €
05,7210														400	519,80 €



Código	Mod.	Ø	Kw	HP	m3/h L/mim	1,0	2,0	2,5	3,0	4,0	5,0	6,0	7,0	Volts	Preço
						40,0	33,3	41,6	50,0	66,6	83,3	100,0	117,0		
05,7215	EH 5/3	1.¼" x 1"	0,55	0,75	H (m)	35	33	32	30	28	25	20	10	230	275,20 €
05,7216														400	275,20 €
05,7217	EH 5/4	1.¼" x 1"	0,9	1,2		45	44	42	40	38	34	28	20	230	311,30 €
05,7218														400	311,30 €
05,7219	EH 5/5	1.¼" x 1"	1,1	1,5		56	54	53	50	47	42	35	25	230	347,60 €
05,7220														400	347,60 €
05,7221	EH 5/6	1.¼" x 1"	1,3	1,8		68	65	62	60	56	50	43	25	230	447,50 €
05,7222														400	447,50 €
05,7223	EH 5/7	1.¼" x 1"	1,5	2,0		79	75	74	71	65	59	50	30	230	498,70 €
05,7224														400	498,70 €
05,7225	EH 5/8	1.¼" x 1"	1,85	2,5	89	84	83	80	74	65	55	40	400	621,50 €	
05,7226	EH 5/9	1.¼" x 1"	1,85	2,5	99	95	92	90	83	75	65	40	400	688,40 €	



Código	Mod.	Ø	Kw	HP	m3/h L/mim	2,0	3,0	4,0	6,0	8,0	10,0	12,0	14,0	Volts	Preço
						33,3	50,0	66,6	100,0	133,3	166,6	200,0	233,3		
05,7230	EH 9/2	1.½" x 1.¼"	0,75	1,0	H (m)	24	23	22	20	18	15	12	10	230	305,40 €
05,7231														400	305,40 €
05,7232	EH 9/3	1.½" x 1.¼"	1,1	1,5		34	33	32	30	27	24	19	10	230	338,60 €
05,7233														400	338,60 €
05,7234	EH 9/4	1.½" x 1.¼"	1,5	2,0		46	44	43	40	36	32	25	10	230	423,20 €
05,7235														400	423,20 €
05,7236	EH 9/5	1.½" x 1.¼"	1,85	2,5		56	55	54	50	45	38	31	10	400	544,30 €
05,7237	EH 9/6	1.½" x 1.¼"	2,2	3,0		68	66	64	60	54	47	37	20	400	642,40 €

Nota: Esta tabela pode ser alterada sem aviso prévio, preços sujeitos à taxa de I.v.a. em vigor.

Setúbal, 01 de Janeiro de 2018.



Hidrosado, Lda.

Quinta Varzinha, Lote 25

2900-721 Setúbal

Telefone: 265537550

Fax: 265537551

Mail: geral@hidrosado.pt

Site: www.hidrosado.pt

Eletrobombas

ALANOL®
ELECTROBOMBAS SUBMERSÍVEIS, S.A.

Eletrobombas Multicelulares Inox com autoclave 24 Lts - Super Domus



Código	Mod.	Ø	Kw	HP	m3/h L/mim	1,5	2,0	2,5	3,0	3,2	3,5	4,0	4,5	Volts	Preço
						25,0	33,3	41,6	50,0	53,3	58,3	66,6	75,0		
05,7240	EH 3/4	1.¼"x1"	0,55	0,75	H (m)	40	38	35	30	29	28	25	20	230	335,44 €
05,7241	EH 3/5	1.¼"x1"	0,75	1,0		50	47	45	40	37	35	30	25	230	359,74 €
05,7242	EH 3/6	1.¼"x1"	0,9	1,2		60	55	52	48	45	40	35	30	230	401,94 €

Código	Mod.	Ø	Kw	HP	m3/h L/mim	1,0	2,0	2,5	3,0	4,0	5,0	6,0	7,0	Volts	Preço
						40,0	33,3	41,6	50,0	66,6	83,3	100,0	117,0		
05,7245	EH 5/4	1.¼"x1"	0,9	1,2	H (m)	45	44	42	40	38	34	28	20	230	365,64 €
05,7246	EH 5/5	1.¼"x1"	1,1	1,5		56	54	53	50	47	42	35	25	230	401,94 €
05,7247	EH 5/6	1.¼"x1"	1,3	1,8		68	65	62	60	56	50	43	25	230	501,84 €
05,7248	EH 5/7	1.¼"x1"	1,5	2,0		79	75	74	71	65	59	50	30	230	553,00 €

Eletrobombas Multicelulares Inox com autoclave 24Lts horizontal



Código	Mod.	Ø	Kw	HP	m3/h L/mim	1,5	2,0	2,5	3,0	3,2	3,5	4,0	4,5	Volts	Preço
						25,0	33,3	41,6	50,0	53,3	58,3	66,6	75,0		
05,7250	EH 3/5	1.¼"x1"	0,75	1,0	H (m)	50	47	45	40	37	35	30	25	230	441,10 €
05,7251	EH 3/6	1.¼"x1"	0,9	1,2		60	55	52	48	45	40	35	30	230	484,70 €

Código	Mod.	Ø	Kw	HP	m3/h L/mim	1,0	2,0	2,5	3,0	4,0	5,0	6,0	7,0	Volts	Preço
						40,0	33,3	41,6	50,0	66,6	83,3	100,0	117,0		
05,7255	EH 5/4	1.¼"x1"	0,9	1,2	H (m)	45	44	42	40	38	34	28	20	230	447,20 €
05,7256	EH 5/5	1.¼"x1"	1,1	1,5		56	54	53	50	47	42	35	25	230	484,70 €
05,7257	EH 5/6	1.¼"x1"	1,3	1,8		68	65	62	60	56	50	43	25	230	587,50 €

Eletrobombas Multicelulares Inox com Pressocontrol 2000



Código	Mod.	Ø	Kw	HP	m3/h L/mim	1,5	2,0	2,5	3,0	3,2	3,5	4,0	4,5	Volts	Preço
						25,0	33,3	41,6	50,0	53,3	58,3	66,6	75,0		
05,7260	EH 3/5	1.¼"x1"	0,75	1,0	H (m)	50	47	45	40	37	35	30	25	230	390,00 €
05,7261	EH 3/6	1.¼"x1"	0,9	1,2		60	55	52	48	45	40	35	30	230	433,70 €
05,7262	EH 3/7	1.¼"x1"	1,1	1,5		70	65	60	55	50	45	40	35	230	474,20 €

Código	Mod.	Ø	Kw	HP	m3/h L/mim	1,0	2,0	2,5	3,0	4,0	5,0	6,0	7,0	Volts	Preço
						40,0	33,3	41,6	50,0	66,6	83,3	100,0	117,0		
05,7265	EH 5/5	1.¼"x1"	1,1	1,5	H (m)	56	54	53	50	47	42	35	25	230	433,70 €
05,7266	EH 5/6	1.¼"x1"	1,3	1,8		68	65	62	60	56	50	43	25	230	536,40 €

Nota: Esta tabela pode ser alterada sem aviso prévio, preços sujeitos à taxa de I.v.a. em vigor.

Setúbal, 01 de Janeiro de 2018.

Pág.: 34

Electrobombas Trasfega

Utilizações: Bombas para trasfega de líquidos neutros e limpos ou com apenas uma pequena percentagem de sólidos (0,2-0,5% máx). Grande capacidade auto-ferrante. Indicadas para trasfega de água, vinho, gasóleo, óleo, misturas, etc.



Código	Mod.	Ø	r.p.m	HP	m³/h	0	0,6	1,2	1,5	2,1	2,7	3,6	4,8	6,0	7,2	13,2	Volts	Preço	
04,4090	Rover 20 CE	¾"	2850	0,5	H (m)	25	16,0	7,0	3,0								230 V	86,11 €	
04,4091	Rover 25 CE	1"	2850	0,8		25	20,0	13,0	9,0	3,0								230 V	110,87 €
04,4092	Rover 30 CE	1,¼"	2850	1,0		20	16,0	14,0	10,0	7,0	6,0	4,0	3,0					230 V	161,26 €
04,4093	Rover 40 CE	1,½"	1450	1,0		15	11,0	10,0	9,0	7,0	6,0	4,0	3,0					230 V	207,33 €
04,4030	BE-20	¾"	2850	0,5		25,0	16,0	7,0	3,0									230 V	99,35 €
04,4031	BE-25	1"	1450	0,6		12,0	9,0	6,0	5,5	1,5								230 V	132,13 €
04,4034						400 V	166,90 €												
04,4032	BE-30	1,¼"	1450	1,0		12,0	11,0	9,5	9,0	8,0	5,0	3,0	0,5					230 V	192,36 €
04,4035						400 V	203,68 €												
04,4033	BE-40	1,½"	1450	1,2		12,0	11,0	10,0	9,5	8,5	7,0	5,0	3,0	1,0				230 V	251,01 €
04,4036						400 V	248,96 €												
04,4037	BE-50	2"	1450	3,0		25,0	24,0	23,0	22,0	21,0	20,0	19,0	17,0	14,0	12,0	3,0		230 V	551,66 €
04,4038						400 V	557,33 €												
04,4039	Novax 20 - Inox	¾"	2850	0,5		25,0	16,0	7,0	3,0									230 V	121,61 €
04,4055	Novax 25 - Inox	1"	1450	0,6		15,0	12,0	8,5	6,5	2,0								230 V	196,61 €
04,5058						400 V	223,80 €												
04,4056	Novax 30 - Inox	1,¼"	1450	1,0		15,0	13,0	11,0	10,5	8,5	7,0	4,0	1,0					230 V	268,75 €
04,4059						400 V	282,90 €												
04,4057	Novax 40 - Inox	1,½"	1450	1,2		15,0	14,0	12,0	11,5	10,0	9,0	7,0	4,0	1,0				230 V	328,16 €
04,4060						400 V	333,83 €												
04,4061	Novax 50 - Inox	2"	1450	3,0	25,0	24,0	23,0	22,0	21,0	20,0	19,0	17,0	14,0	12,0	3,0		230 V	622,76 €	
04,4062					400 V	619,56 €													
04,4063	Marina Novax 20	¾"	2850	0,6	24,0	15,0	6,0	2,0									12 V	271,60 €	
04,4064	Marina Novax 25	1"	2850	1,0	24,0	19,0	13,0	10,0	4,0								12 V	291,40 €	

Utilizações: Filtro-prensa de painéis apropriado para filtragem do vinho antes do engarrafamento. Recargas de Filtros: 20x20cm.



Kit Diesel - Tubo gasóleo (5m) + pistola manual + conector



Código	Mod.	Ø	HP	Filtro	L/h	Volts	Preço
04,4070	Colombo 6 Inox	¾"	0,5	6	200-300	230	415,86 €
04,4071	Colombo 12 Inox	¾"	0,5	12	350-500	230	461,13 €
04,4072	Colombo 18 Inox	¾"	0,5	18	550-800	230	509,21 €

Código	Designação	Preço
04,4080	Kit diesel 20mm - ¾"	51,06 €
04,4081	Kit diesel 25mm - 1"	66,88 €
04,4082	Contador	127,70 €

Nota: Esta tabela pode ser alterada sem aviso prévio, preços sujeitos à taxa de I.v.a. em vigor.

Setúbal, 01 de Janeiro de 2018.



Hidrosado, Lda.

Quinta Varzinha, Lote 25

2900-721 Setúbal

Telefone: 265537550

Fax: 265537551

Mail: geral@hidrosado.pt

Site: www.hidrosado.pt

Autoclaves diversos



Código	Capacidade Litros	Bar	Dimensão Exterior	Record Saída	Altura Total	Preço
07,0998	5	10	160	½"	270	32,57 €
07,0999	8	10	220	½"	295	34,74 €
07,1000	24	8	360	1"	355	32,57 €
07,1019	24 horiz.	10	270	1"	290	56,45 €
07,1001	60	10	380	1"	860	136,25 €
07,1015	80	10	450	1"	830	188,91 €
07,1002	100	10	450	1"	910	232,34 €
07,1003	200	10	550	1.½"	1235	403,88 €
07,1004	300	10	630	1.½"	1365	503,77 €
07,1005	500	10	750	1.½"	1560	869,65 €

Autoclaves em chapa pintada e inox

07,1018	40	8	360	1"	710	87,94 €
07,1020	40 horiz.	8	360	1"	380	89,00 €

Autoclaves Alanol Aço Inox c/ Membrana verticais 6 Bars

07,2070	24 Lts		310	1"	410	120,00 €
07,2071	60 Lts		380	1"	860	276,42 €
07,2072	100 Lts		450	1"	910	341,78 €
07,2073	200 Lts		550	1.½"	1235	582,85 €
07,2074	300 Lts		630	1.½"	1365	701,78 €
07,2075	500 Lts		750	1.½"	1560	1.308,21 €

Autoclaves Alanol Aço Inox reforçado c/ Membrana verticais 10 bars

07,1030	100 Lts		480	1"	940	444,65 €
07,1031	200 Lts		560	1.¼"	1340	692,16 €
07,1032	300 Lts		640	1.¼"	1340	830,38 €
07,1033	500 Lts		640	1.½"	1670	1.639,34 €

Autoclaves em Fibra c/ Membrana - WELLMATE 7 bars

07,3511	60 Lts		410	1"	660	267,50 €
07,3512	75 Lts		410	1"	810	285,00 €
07,3513	120 Lts		410	1"	1120	424,16 €
07,3514	150 Lts		410	1"	1450	504,16 €
07,3515	180 Lts		530	1.¼"	1050	610,83 €
07,3516	235 Lts		610	1.¼"	1050	720,00 €
07,3517	330 Lts		610	1.¼"	1400	904,16 €
07,3518	450 Lts		610	1.¼"	1890	1.178,34 €
07,3519	600 Lts		760	2"	1740	2.307,50 €

Membranas para Autoclave Zilmet

07,5006	Membrana Zilmet	redondo 24 Lts		4,20 €
07,5007	Membrana Zilmet	40 Lts		19,00 €
07,5001	Membrana Zilmet	60 Lts/80 Lts		21,71 €
07,5002	Membrana Zilmet	100 Lts		44,52 €
07,5003	Membrana Zilmet	200 Lts		160,68 €
07,5004	Membrana Zilmet	300 Lts		148,74 €
07,5005	Membrana Zilmet	500 Lts		404,00 €

Membranas para Autoclave Well Mate

07,3540	Membrana Well Mate	60 Lts		115,00 €
07,3541	Membrana Well Mate	75 Lts		135,00 €
07,3542	Membrana Well Mate	120 Lts		189,00 €
07,3543	Membrana Well Mate	150 Lts		229,00 €
07,3544	Membrana Well Mate	180 Lts		276,00 €
07,3545	Membrana Well Mate	235 Lts		322,00 €
07,3546	Membrana Well Mate	330 Lts		404,00 €



Nota: Esta tabela pode ser alterada sem aviso prévio, preços sujeitos à taxa de I.v.a. em vigor.

Setúbal, 01 de Janeiro de 2018.

Pág.: 36



Hidrosado, Lda.
 Quinta Varzinha, Lote 25
 2900-721 Setúbal
 Telefone: 265537550
 Fax: 265537551
 Mail: geral@hidrosado.pt
 Site: www.hidrosado.pt

Autoclaves diversos



Thinking solutions.

Código	Capacidade Litros	Bar	Dimensão Exterior	Record Saída	Altura Total	Preço
--------	-------------------	-----	-------------------	--------------	--------------	-------

Autoclaves Reflex

07,3550	8	10	206	3/4"	320	42,50 €
07,3551	12	10	280	3/4"	310	43,33 €
07,3552	18	8	280	3/4"	380	45,00 €
07,3553	25	10	280	3/4"	500	45,00 €
07,3554	60	10	409	1"	740	145,00 €
07,3555	80	10	480	1"	730	175,83 €
07,3556	100	10	480	1"	835	252,50 €
07,3557	200	10	634	1.1/4"	970	396,67 €
07,3558	300	10	634	1.1/4"	1270	486,67 €
07,3559	500	10	740	1.1/4"	1475	818,33 €



Autoclaves



07,3600	24	6	318	1"	380	25,00 €
07,3601	24 horizontal	6	270	1"	290	36,39 €
07,3602	40	6	350	1"	520	80,95 €
07,3603	60	6	398	1"	730	95,24 €
07,3604	80	6	398	1"	800	114,29 €
07,3605	100	6	477	1"	980	130,95 €
07,3606	200	6	560	1.1/2"	1200	297,61 €
07,3607	300	6	560	1.1/2"	1530	400,00 €
07,3608	500	6	710	2"	1720	797,61 €
07,3609	750	6	710	2"	2100	1.000,00 €
07,3610	1000	6	850	2"	2250	1.178,57 €



Autoclaves inox



07,3611	24	6	318	1"	380	100,00 €
07,3612	60	6	398	1"	730	214,28 €
07,3613	80	6	398	1"	800	226,19 €
07,3614	100	6	477	1"	980	300,00 €
07,3615	200	6	560	1.1/2"	1200	500,00 €
07,3616	300	6	560	1.1/2"	1530	658,00 €
07,3617	500	6	710	2"	1720	1.376,00 €
07,3618	750	6	710	2"	2100	2.380,00 €
07,3619	1000	6	850	2"	2250	2.797,60 €



Tampa Flange



07,1027	Tampa flange - 1"	24L a 100L	12,66 €
07,1028	Tampa flange - 1.1/2"	200L e 300L	25,36 €



Válvula para depósito com membrana

07,1035	Válvula para depósito com membrana	1,68 €
---------	------------------------------------	--------



Nota: Esta tabela pode ser alterada sem aviso prévio, preços sujeitos à taxa de I.v.a. em vigor.
 Setúbal, 01 de Janeiro de 2018.



Hidrosado, Lda.
 Quinta Varzinha, Lote 25
 2900-721 Setúbal
 Telefone: 265537550
 Fax: 265537551
 Mail: geral@hidrosado.pt
 Site: www.hidrosado.pt

Pressostatos e acessórios para bombas



Square D



IP - 5 Kg



LP/3



PM-3W



DNKP 35



DNKPI 38



Flumac
Brio 2000



Brio Top



Optimatic



Controlpump



Sirio



Insuflador
de ar



Código	Designação	Preço
07,3015	Pressostato <i>MEW</i> 5Kg 230V	5,38 €
07,3000	Pressostato <i>SQUARE D-FSG2</i> 220V	12,26 €
07,3008	Pressostato <i>ITALTECNICA</i> IP 5Kg - 230V	8,90 €
07,3001	Pressostato <i>ITALTECNICA</i> IP 5Kg - 400V	9,80 €
07,3002	Pressostato <i>ITALTECNICA</i> IP 12Kg - 230V	9,90 €
07,3010	Pressostato inverso baixa pressão - Falta de água - Italtecnica-Azul	13,98 €
07,3011	Pressostato Italtécnica c/Mamometro p/Autoclave - PM/5 - 3W	14,50 €
07,3025	Pressostato Danfoss - DNKP 35 (0,2 - 7,5 bar) - falta água	119,50 €
07,3026	Pressostato Danfoss - DNKPI 38 (8,0 - 28,0 bar)	170,33 €
07,3007	Pressocontrol FLUMAC - Brio 2000 c/manómetro (Interruptor eletrónico de Caudal e pressão)	54,80 €
07,3020	Pressostato eletrónico BRIO Top (Regulador de minimo e máximo)	171,42 €
07,3021	Controlador de pressão Controlpump FM15 (caudal max. 6000 l/h) (Pressão de arranque a 1,5 a 3 bar - Pot. Max. 2HP)	76,76 €
07,3022	Controlador de pressão OPTIMATIC RM (caudal max. 8000 l/h) (Pressão de arranque regulável de 1,5 a 3 bar - Pot. Max. 2HP)	79,23 €
07,3009	Pressostato Telemec - 12 Kg	32,50 €
07,3012	SIRIO - Variador de velocidade 230V até 1,5 Hp	315,84 €
07,3014	SIRIO - Variador de velocidade 3x230V	438,00 €
07,3580	Insuflador de ar	58,28 €
07,3581	Insuflador de ar completo	85,10 €
07,2003	Manómetro 10Kg	3,80 €
07,2001	Manómetro glicerina 10Kg - Aço Inox	10,80 €
07,2005	Manómetro glicerina 12Kg - Aço Inox	12,00 €
07,2004	Curva de plástico 1 x 1 p/brio 2000	4,25 €
07,4000	Tês de 5 vias 1" - CURTOS	5,57 €
07,4001	Tês de 5 vias 1" - GRANDES	6,88 €
07,4003	Tês de 3 vias p/autoclaves	4,12 €

Nota: Esta tabela pode ser alterada sem aviso prévio, preços sujeitos à taxa de I.v.a. em vigor.
 Setúbal, 01 de Janeiro de 2018.



Hidrosado, Lda.

Quinta Varzinha, Lote 25

2900-721 Setúbal

Telefone: 265537550

Fax: 265537551

Mail: geral@hidrosado.pt

Site: www.hidrosado.pt

Quadros eléctricos

Código	Designação	Preço
Quadros Discontactor WEG		230V
11,3100	Quadro discontactor Weg - 1,8 - 10 Amp	97,50 €
11,3101	Quadro discontactor Weg - 8,5 - 12,5 Amp	103,00 €
Quadros Discontactor WEG		400V
11,3106	Quadro discontactor Weg - 1,8 - 10 Amp	101,67 €
11,3107	Quadro discontactor Weg - 8,5 - 12,5 Amp	107,25 €
Quadros de nível WEG		230V
11,3104	Quadro de nível Weg - 1,8 - 10 Amp	113,00 €
11,3105	Quadro de nível Weg - 8,5 - 12,5 Amp	118,00 €
Quadros de nível WEG		400V
11,3110	Quadro de nível Weg - 1,8 - 10 Amp	117,00 €
11,3111	Quadro de nível Weg - 8,5 - 12,5 Amp	122,00 €
Quadros Probomba Digital WEG		
11,3095	Quadro Probomba digital "101"P - 12 A - 230 V	158,29 €
11,3096	Quadro Probomba digital "101"P - 12 A - 400 V	169,80 €
Quadros de nível digital - Mosal		230V
11,3042	Quadro de nível digital com relé Mega 1,0 - 12,5 Amp	207,00 €
Quadros de nível digital - Mosal		400V
11,3043	Quadro de nível digital com relé Mega 1,0 - 12,5 Amp	219,00 €
Quadros de nível + poço + Depósito - WEG		
11,3130	Quadro de nível + poço + depósito - 1,8 - 10 Amp - 230V	140,00 €
11,3131	Quadro de nível + poço + depósito - 8,5 - 12,5 Amp - 230V	145,70 €
11,3132	Quadro de nível + poço + depósito - 1,8 - 10 Amp - 400V	144,00 €
11,3133	Quadro de nível + poço + depósito - 8,5 - 12,5 Amp - 400V	150,00 €
Quadros Discontactor c/alarme - WEG		
11,3016	Quadros Discontactor c/alarme - 230V	151,66 €
11,3044	Quadros Discontactor c/alarme - 400V	160,95 €
Quadro de comando e proteção c/interruptor geral 12120		
11,3083	Quadro de comando e proteção c/interr.geral 6,3...10A - 230 V	136,19 €
Quadro de comando e proteção c/interruptor geral + alarme 1212A		
11,3088	Quadro de comando e proteção c/IG + Alarme 6,3...10A - 230 V	164,00 €
Quadro comando EV		
11,3065	Quadro de comando para eléctroválvulas EV 24V p/depósito	99,00 €



Nota: Esta tabela pode ser alterada sem aviso prévio, sujeito à taxa de I.v.a. em vigor.
Setúbal, 01 de Janeiro de 2018.



Hidrosado, Lda.

Quinta Varzinha, Lote 25

2900-721 Setúbal

Telefone: 265537550

Fax: 265537551

Mail: geral@hidrosado.pt

Site: www.hidrosado.pt

Quadros eléctricos

Código	Designação	Preço
--------	------------	-------

**Quadro de alternância p/2 eletrobombas
em armário transparente - 33020**

11,3091	Quadro alternância 2 Bombas 33020 1,8...10A - 230 V	306,42 €
11,3092	Quadro alternância 2 Bombas 33020 8,0...12A - 230 V	325,00 €
11,3093	Quadro alternância 2 Bombas 33020 1,8...10A - 400 V	306,42 €
11,3094	Quadro alternância 2 Bombas 33020 8,0...12A - 400 V	325,00 €



**Quadros de alternância para 2 electrobombas
c/alarque em armário transparente**

11,3032	Quadro de alter. c/alarque ref. 3303A - 1,8 - 10 Amp - 230V	349,76 €
11,3033	Quadro de alter. c/alarque ref. 3303A - 8,5 - 12,5 Amp - 230V	368,33 €
11,3046	Quadro de alter. c/alarque ref. 3303A - 1,8 - 10 Amp - 400V	349,76 €
11,3035	Quadro de alter. c/alarque ref. 3303A - 8,5 - 12,5 Amp - 400V	368,33 €



**Quadros de alternância p/2 electrobombas
A2444 c/armário em poliéster - Schneider**

11,3170	Quadro de alter. ref. A2444 - 1,8 - 10 Amp - 230V	600,47 €
11,3171	Quadro de alter. ref. A2444 - 8,0 - 12,5 Amp - 230V	631,42 €
11,3172	Quadro de alter. ref. A2444 - 1,8 - 10 Amp - 400V	600,47 €
11,3173	Quadro de alter. ref. A2444 - 8,0 - 12,5 Amp - 400V	631,42 €



**Quadros de alternância c/alarque
Armário em poliéster p/2 electrobombas - Schneider**

11,3175	Quadro de alter. c/alarque ref. A2455 - 1,8 - 10 Amp - 230V	708,80 €
11,3176	Quadro de alter. c/alarque ref. A2455 - 8,5 - 12,5 Amp - 230V	739,76 €
11,3177	Quadro de alter. c/alarque ref. A2455 - 1,8 - 10 Amp - 400V	755,23 €
11,3178	Quadro de alter. c/alarque ref. A2455 - 8,5 - 12,5 Amp - 400V	786,19 €



**Quadros de arranque progressivo c/Relé de Nível
Schneider**

11,3180	Quadro arr. progr. c/relé ref. S1325S - 7,5 Hp 10,0 - 16,0 Amp - 400V	774,00 €
11,3181	Quadro arr. progr. c/relé ref. S1325S - 10,0 Hp 16,0 - 20,0 Amp - 400V	774,00 €
11,3182	Quadro arr. progr. c/relé ref. S1325S - 12,5 Hp 20,0 - 25,0 Amp - 400V	999,50 €
11,3183	Quadro arr. progr. c/relé ref. S1325S - 15,0 Hp 25,0 - 32,0 Amp - 400V	1.021,50 €



**Quadros de arranque progressivo c/Relé de Nível
Schneider**

11,3185	Quadro arr. progr. c/relé ref. S1345S - 7,5 Hp 13,0 - 18,0 Amp - 400V	990,50 €
11,3186	Quadro arr. progr. c/relé ref. S1345S - 10,0 Hp 17,0 - 22,0 Amp - 400V	1.021,50 €
11,3187	Quadro arr. progr. c/relé ref. S1345S - 12,5 Hp 20,0 - 25,0 Amp - 400V	1.176,00 €
11,3188	Quadro arr. progr. c/relé ref. S1345S - 15,0 Hp 25,0 - 32,0 Amp - 400V	1.269,00 €



**Quadros de arranque progressivo c/Relé de Nível
WEG**

11,3190	Quadro arr. progr. c/relé ref. S1345W - 14,0 - 45,0 Amp - 400V	1.640,50 €
11,3191	Quadro arr. progr. c/relé ref. S1345W - 18,0 - 60,0 Amp - 400V	1.888,00 €
11,3192	Quadro arr. progr. c/relé ref. S1345W - 24,0 - 80,0 Amp - 400V	2.104,00 €



Nota: Esta tabela pode ser alterada sem aviso prévio, sujeito à taxa de I.v.a. em vigor.

Setúbal, 01 de Janeiro de 2018.



Hidrosado, Lda.

Quinta Varzinha, Lote 25

2900-721 Setúbal

Telefone: 265537550

Fax: 265537551

Mail: geral@hidrosado.pt

Site: www.hidrosado.pt

Quadros eléctricos

Código	Designação	Preço
--------	------------	-------

Quadros de arranque Estrela/Triângulo Schneider

C/Relé nível + Relé sequência e falta de fase

11,3210	Quadro estrela/triângulo c/relé ref. U133 - 10,0 - 16,0 Amp - 400V	696,42 €
11,3211	Quadro estrela/triângulo c/relé ref. U133 - 16,0 - 20,0 Amp - 400V	696,42 €
11,3212	Quadro estrela/triângulo c/relé ref. U133 - 20,0 - 25,0 Amp - 400V	727,38 €
11,3213	Quadro estrela/triângulo c/relé ref. U133 - 25,0 - 32,0 Amp - 400V	789,28 €
11,3214	Quadro estrela/triângulo c/relé ref. U133 - 28,0 - 41,0 Amp - 400V	1.067,85 €
11,3215	Quadro estrela/triângulo c/relé ref. U133 - 40,0 - 55,0 Amp - 400V	1.222,61 €
11,3216	Quadro estrela/triângulo c/relé ref. U133 - 52,0 - 65,0 Amp - 400V	1.377,38 €
11,3217	Quadro estrela/triângulo c/relé ref. U133 - 64,0 - 86,0 Amp - 400V	1.702,38 €



Quadro de variação velocidade p/1 electrobomba

11,3080	Quadro variação velocidade 4 - 3,6 Amp - 400V	1.823,00 €
11,3081	Quadro variação velocidade 6 - 10,0 Amp - 400V	1.974,00 €
11,3082	Quadro variação velocidade 9 - 13,0 Amp - 400V	2.428,00 €



Quadro de variação velocidade p/2 electrobombas

11,3085	Quadro variação velocidade 2,5 - 4,0 Amp - 400V	2.225,00 €
11,3086	Quadro variação velocidade 4,0 - 6,0 Amp - 400V	2.315,00 €
11,3087	Quadro variação velocidade 6,0 - 9,0 Amp - 400V	2.619,00 €



Transdutor de pressão

11,3090	Transdutor de pressão 0-10 bar c/saída 4,20 ma	240,00 €
---------	--	----------



Variador de velocidade Universal

11,3120	Variador UM GD200A 1,5kW 380/400V c/filtro	340,61 €
11,3121	Variador UM GD200A 2,2kW 380/400V c/filtro	406,68 €
11,3122	Variador UM GD200A 4/5,5kW 380/400V c/filtro	479,66 €



Quadro inversor de rede automático

11,3220	Quadro inversor de rede automático X1GA2	696,42 €
---------	--	----------



Quadro simples de comando c/térmico s/condensador

11,3230	Quadro de comando s/condensador e proteção térmica 00M02 - 5A	44,26 €
11,3231	Quadro de comando s/condensador e proteção térmica 00M02 - 6A	44,26 €
11,3232	Quadro de comando s/condensador e proteção térmica 00M02 - 7A	44,26 €
11,3233	Quadro de comando s/condensador e proteção térmica 00M02 - 8A	44,26 €
11,3234	Quadro de comando s/condensador e proteção térmica 00M02 - 10A	44,26 €
11,3235	Quadro de comando s/condensador e proteção térmica 00M02 - 12A	44,26 €



Quadros com diferentes amperagem sob consulta

Nota: Esta tabela pode ser alterada sem aviso prévio, sujeito à taxa de I.v.a. em vigor.
Setúbal, 01 de Janeiro de 2018.



Hidrosado, Lda.
 Quinta Varzinha, Lote 25
 2900-721 Setúbal
 Telefone: 265537550
 Fax: 265537551
 Mail: geral@hidrosado.pt
 Site: www.hidrosado.pt

Material Eléctrico

Diverso



Código	Designação	Preço
--------	------------	-------

Blocos térmicos WEG

11,1025	Bloco térmico WEG - 1,0 A a 10,0 A	51,19 €
11,1026	Bloco térmico WEG - 8,0 A a 12,5 A	54,60 €

Contatores simples WEG

11.1050	Contator simples WEG - 9,30, 10A 230V	39,97 €
11.1051	Contator simples WEG - 9,30, 10A 400V	39,97 €

Bobines WEG e Telemecanique

11.1033	Bobines - 230V	14,40 €
11.1011	Bobines - 400V	14,40 €

Boiadores de nível

11.1035	Boiadores de nível com peso - 3,00 mts (Italianos)	13,00 €
11.1036	Boiadores de nível com peso - 5,00 mts	15,00 €
11.2011	Boiadores ecológicos RNC 1002 - c/cabo 10 mts	79,80 €

Sondas de nível

11.3003	Sondas de nível	3,71 €
---------	-----------------	--------

Acessórios para vulcanização

11.3015	kit de vulcanização	7,89 €
11.2027	Barra completa para vulcanizar	24,44 €
11,1060	Kit 1,5 mts cabo com ficha para eletrobombas	4,33 €

Cabo elétrico H07V - K - FV

11,4035	Cabo elétrico FV 1,5	0,205 €
11,4033	Cabo elétrico FV 2,5	0,324 €
11,4036	Cabo elétrico FV 4,0	0,534 €

Cabo elétrico H05VV - FVV

11,4000	Cabo elétrico FVV 2 x 1,5	0,633 €
11,4019	Cabo elétrico FVV 2 x 2,5	1,090 €
11,4014	Cabo elétrico FVV 3 x 1,5	0,948 €
11,4012	Cabo elétrico FVV 3 x 2,5	1,433 €
11,4016	Cabo elétrico FVV 4 x 1,5	1,220 €
11,4017	Cabo elétrico FVV 4 x 2,5	1,850 €
11,4001	Cabo elétrico FVV 5 x 1,5	1,510 €
11,4030	Cabo elétrico FVV 5 x 2,5	2,374 €

Cabo elétrico RV - K - FXV

11,4040	Cabo elétrico FXV 2 x 1,5	0,782 €
11,4041	Cabo elétrico FXV 3 x 1,5	0,953 €
11,4042	Cabo elétrico FXV 4 x 2,5	1,947 €
11,4043	Cabo elétrico FXV 4 x 4	2,656 €
11,4044	Cabo elétrico FXV 4 x 6	4,180 €

Nota: Devido aos valores instáveis do cobre é aconselhável verificar sempre o preço dos cabos.

Abraçadeiras serrilha

09.3023	150 mm (10 Unidades)	0,84 €
09.3020	200 mm (10 Unidades)	1,36 €
09.3021	310 mm (10 Unidades)	1,99 €
09.3030	370 mm (10 Unidades)	2,78 €
09.3031	500 mm (10 Unidades)	3,63 €

Nota: Esta tabela pode ser alterada sem aviso prévio, preços sujeitos à taxa de I.v.a. em vigor.
 Setúbal, 01 de Janeiro de 2018.

Relés

Diversos

Código	Designação	Volts	Ref.	Preço
Relés 24/230/400VAC				
11.5000	Relé de nível - Controlo de Enchimento		411-RND20	32,33 €
11.5001	Relé de nível - Controlo de Enchimento sensibilidade regulável		411-RND21	34,00 €
11.5002	Relé de nível - Controlo de Enchimento		411-RNDS0	30,66 €
11.5003	Relé de nível - Controlo de Enchimento sensibilidade regulável		411-RNP11	33,00 €
11.5004	Relé de nível - Controlo de Esvaziamento		411-RNP20	32,33 €
11.5005	Relé de nível - Controlo de Esvaziamento sensibilidade regulável		411-RNP21	34,00 €
11.5006	Relé de nível - Controlo de Esvaziamento poços e furos artesianos		411-RNPS0	32,33 €
11.5007	Relé de nível - Controlo de Esvaziamento com rearme temporizado		411-RNPT1	43,00 €
11.5008	Relé de nível - Controlo de poço e depósito		411-RNPD0	42,33 €
11.5009	Relé de nível - Controlo de Esvaziamento para caldeiras		411-RNC11	43,00 €
11.5010	Relé de nível - Comando de compressor deposito hidropneumático		411-RNCC1	43,00 €
11.5011	Relé de alternância - Comando para 2 bombas		411-RA220	46,33 €
11.5012	Relé de alternância - Comando para 2 bombas c/temporização		411-RA221	54,66 €
11.5013	Relé de alternância - Comando para 2 bombas + alarme		411-RA22A	61,33 €
11.5014	Relé de alternância - Comando para 2 bombas efluentes + alarme		411-RA23A	61,33 €
11.5015	Relé de alternância - Comando para 3 bombas		411-RA330	69,66 €
11.5016	Relé de alternância e nível - Comando para 2 bombas		411-RAN20	54,66 €
11.5017	Relé temporizador - Comando de arranque de motores estrela-Triângulo		411-RTET1	44,66 €
11.5018	Relé temporizador - Comando de arranque de motores auto-indutora		411-RTAI1	44,66 €
11.5019	Relé temporizador - Multifunção (TAO + TOS + TIT) - Multiescala		411-RTMFM	48,00 €
11.5020	Relé temporizador - Atraso à operação - multiescala		411-RTAOM	48,00 €
11.5021	Relé temporizador - Interruptor temporizado - Multiescala		411-RTITM	48,00 €
11.5022	Relé temporizador - Atraso à desoperação (por corte de alimentação)		411-RTAD1	48,00 €
11.5023	Relé temporizador - Atraso à operação e desoperação		411-RTAOD	48,00 €
11.5024	Relé temporizador - Interruptor temporizado com atraso à operação		411-RTITA	43,00 €
11.5025	Relé temporizador - Oscilador assimétrico		411-RTOA1	43,00 €
11.5026	Relé temporizador - Oscilador assimétrico com sistema de alternância		411-RTOP2	51,33 €
11.5027	Relé supervisor de tensão - Monofásico com temporização		411-RV12T	48,00 €
11.5028	Relé de falta de fase - Proteção na falta/assimetria de fase		411-RVFF1	39,66 €
11.5029	Relé de falta de fase - Proteção na falta/assimetria de fase ou neutro		411-RVFFN	41,33 €
11.5030	Relé de sequência e falta de fase - Proteção na troca ou falta/assimetria fase		411-RVSF0	39,66 €
11.5031	Relé de sequência e falta de fase - Proteção na troca ou falta/assimetria fase		411-RVSF1	41,33 €
11.5032	Relé de sequência e falta de fase - Proteção na troca ou falta/assimetria fase ou neutro		411-RVSFN	41,33 €
11.5033	Relé de sequência e falta de fase - Proteção na troca ou falta/assimetria fase c/atraso		411-RVSFT	48,00 €
11.5035	Relé probomba digital		452-PROBD21P	133,33 €
11.5040	Relé de nível - Mosal		RN11	33,00 €
11.5041	Relé de alterância s/temporização - Mosal		RB31	57,00 €
11.5042	Relé temporizado - Mosal		RDN	166,00 €
11.5043	Relé de nível + depósito - Mosal		RN21	46,45 €
11.5044	Relé de sequência de fases - Mosal		RU81	79,36 €
11.5045	Relé 24V auxiliar - C.I. 2INV 8A B-24VAC		2INV	8,34 €
11.5050	Sinalizadores 9mm - Vermelho, Verde e Amarelo		1SIN092	2,78 €
11.5055	Alarme sonoro para painel 24/230V		IALSPBF	13,67 €
11.3001	Bases para relés de nível MEGA 11 pinos - 230V/400V		1BASR119023	5,10 €
11.5060	Interruptor horário analógico 2 mod - Com Reserva		11NTHAH4	61,75 €
11.5061	Interruptor horário digital 2 mod - Com Reserva		11NTHDST	61,75 €

Nota: Esta tabela pode ser alterada sem aviso prévio, preços sujeitos à taxa de I.v.a. em vigor.

Setúbal, 01 de Janeiro de 2018.

Pág.: 43



Hidrosado, Lda.

Quinta Varzinha, Lote 25

2900-721 Setúbal

Telefone: 265537550

Fax: 265537551

Mail: geral@hidrosado.pt

Site: www.hidrosado.pt

Electrobombas

e

Filtro Piscina



Eletrobomba para piscina - Auto-ferrante



Código	Mod.	Ø	Kw	HP	m³/h	H(m)																Volts	Preço																
						2,4	4,8	7,2	9,6	12	13,5	16	17,4	20,4	24	27	30	33	L/mim	40	80			120	160	200	225	265	290	340	400	450	500	550					
28,2100	FCP 370S	50	0,37	0,5		12,4	12,3	12,0	10,7	8,5																											230	259,00 €	
28,2101	FCP 550S	50	0,55	0,75		15,0	14,9	14,8	13,6	11,8	10,5	7,8																										230	267,00 €
28,2102	FCP 750S	50	0,75	1		16,8	16,6	16,2	15,3	13,7	12,3	9,5	7,5																									230	283,00 €
28,2103	FCP 1100S	50	1,1	1,5		18,0	17,2	16,6	15,8	14,5	13,8	13,0	11,0	8,5																								230	328,00 €
28,2104	FCP 1500S	63	1,5	2		18,6	18,3	18,0	17,9	17,8	17,3	16,9	16,3	15,0	13,0	11,0	9,0	6,8																				230	476,00 €
28,2105	FCP 2200S	63	2,2	3		21,0	21,0	20,9	20,9	20,5	20,1	19,8	19,5	18,5	17,0	15,4	12,6	7,2																				230	506,00 €
28,2106	FCP 750ST	50	0,75	1		16,8	16,6	16,2	15,3	13,7	12,3	9,5	7,5																									400	283,00 €
28,2107	FCP 1100ST	50	1,1	1,5		18,0	17,2	16,6	15,8	14,5	13,8	13,0	11,0	8,5																								400	328,00 €
28,2108	FCP 1500ST	63	1,5	2		18,6	18,3	18,0	17,9	17,8	17,3	16,9	16,3	15,0	13,0	11,0	9,0	6,8																				400	459,00 €
28,2109	FCP 2200ST	63	2,2	3		21,0	21,0	20,9	20,9	20,5	20,1	19,8	19,5	18,5	17,0	15,4	12,6	7,2																				400	483,00 €

Filtro de piscina com válvula

Código	Mod.	Ø	Caudal m³/h	Caudal m³	Volume areia	Dimensões (mm)					Preço
						Q	H	A	C	E	
28,2200	FB 500	50	6	48	120	500	811	460	551	470	397,00 €
28,2201	FB 600	50	9	72	200	600	891	460	594	513	504,00 €
28,2202	FB 750	63	13	104	300	750	1006	590	643	562	749,00 €

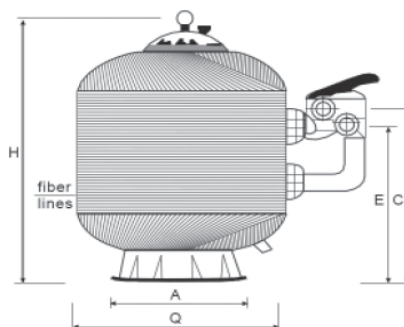

Nota: Esta tabela pode ser alterada sem aviso prévio, preços sujeitos à taxa de I.v.a. em vigor.

Setúbal, 01 de Janeiro de 2018.

Pág.: 44



Hidrosado, Lda.
 Quinta Varzinha, Lote 25
 2900-721 Setúbal
 Telefone: 265537550
 Fax: 265537551
 Mail: geral@hidrosado.pt
 Site: www.hidrosado.pt

Artigos de Piscina

Bombas de piscina

Código	Designação	Ø	Volts	HP	H.M.T.	L/H	Preço
28,1280	Silen S 60 - 12	2"	230V	0,60	6,7 - 12 mts	12 900 - 2 400	318,00 €
28,1281	Silen S 75 - 15	2"	230V	0,75	6,0 - 15 mts	15 200 - 6 000	325,00 €
28,1282	Silen S 100 - 18	2"	230V	1,00	5,9 - 18 mts	16 900 - 5 900	336,00 €
28,1283	Silen S 150 - 22	2"	230V	1,50	5,1 - 22 mts	18 600 - 5 100	404,00 €
28,1284	Silen S2 200 - 31	2"	230V	2,00	6,3 - 31 mts	19 500 - 6 300	526,00 €
28,1285	Silen S 75 - 15	2"	400V	0,75	6,0 - 15 mts	15 200 - 6 000	325,00 €
28,1286	Silen S 100 - 18	2"	400V	1,00	4,0 - 18 mts	16 900 - 5 900	336,00 €
28,1287	Silen S2 150 - 29	2"	400V	1,50	5,5 - 29 mts	18 500 - 5 500	389,00 €
28,1288	Silen S2 200 - 31	2"	400V	2,00	6,3 - 31 mts	19 500 - 6 300	496,00 €
28,1289	Silen S2 300 - 36	2"	400V	3,00	5,0 - 36 mts	21 500 - 5 000	630,00 €



Filtros de Piscina Laminados

Código	Designação	Preço
28,1270	Filtro de areia - Ø 500 - 9 m ³ /h - c/ Válvula 1.1/2" - 84003	494,00 €
28,1271	Filtro de areia - Ø 650 - 15 m ³ /h - c/ Válvula 1.1/2" - 84004	575,00 €
28,1272	Filtro de areia - Ø 800 - 24 m ³ /h - c/ Válvula 2" - 84006	854,00 €
28,1273	Filtro de areia - Ø 950 - 35 m ³ /h - c/ Válvula 2" - 84007	1.182,00 €



Filtros de Piscina Triton 1

Código	Designação	Preço
28,1120	Filtros de areia TR 40 - 8.5 m ³ /h - c/ Válvula 1.1/2" - 84152	789,00 €
28,1121	Filtros de areia TR 60 - 14 m ³ /h - c/ Válvula 1.1/2" - 84153	928,50 €
28,1122	Filtros de areia TR100 - 22 m ³ /h - c/ Válvula 2" - 84154	1.371,80 €
28,1123	Filtros de areia TR140 - 32 m ³ /h - c/ Válvula 2" - 84155	1.900,00 €



Filtros de Piscina Powerline Hayward

Código	Designação	Preço
28,1274	Filtro de areia Powerline 500 - c/válvula lateral - 81113	424,00 €
28,1275	Filtro de areia Powerline 600 - c/válvula lateral - 81114	487,50 €
28,1276	Filtro de areia Powerline 600 - c/válvula de topo - 84020361	426,50 €



Filtros Compatos + Bomba

Código	Designação	Preço
28,1277	Compacto 350 + bomba - 0,25 HP - 84020050	445,00 €
28,1278	Compacto 400 + bomba - 0,33 HP - 84020051	477,00 €
28,1279	Compacto 500 + bomba - 0,50 HP - 84020052	611,00 €



Sistema de filtração completo em polietileno para enterrar

Código	Designação	Preço
28,1143	Caixa pequena - c/filtro laminado 550 c/válvula de topo + Bomba 1HP	1.540,00 €
28,1144	Caixa grande - c/filtro laminado 600 c/válvula de topo + Bomba 1HP	1.967,00 €



Tube Hidroflex p/piscinas - colar

Código	Ø	Preço
12,7055	50mm	3,571 €
12,7056	63mm	5,785 €



Nota: Esta tabela pode ser alterada sem aviso prévio, preços sujeitos à taxa de I.v.a. em vigor.
 Setúbal, 01 de Janeiro de 2018.



Hidrosado, Lda.
 Quinta Varzinha, Lote 25
 2900-721 Setúbal
 Telefone: 265537550
 Fax: 265537551
 Mail: geral@hidrosado.pt
 Site: www.hidrosado.pt

Artigos de Piscina

Skimmers

Código	Designação	Preço
28,1037	Skimmer - 5143 - Boca larga p/betão - 86276	102,50 €
28,1180	Skimmer - Boca larga p/Liner - 86012	139,00 €
28,1112	Flutuador Skimmer - 82177	7,80 €
28,1113	Tampa redonda Skimmer - 82176	10,50 €
28,1105	Cesto para Skimmer - 82179	11,50 €
28,1114	Regulador de nível automático - 85015	80,50 €



Ralo de fundo

28,1185	Ralo de fundo p/betão - 86518	21,50 €
28,1186	Ralo de fundo p/Liner - 86517	51,00 €
28,1265	Grelha ralo de fundo - 030553	7,50 €



Passa muros

28,1063	Passa muros betão com rosca - 86005	9,50 €
28,1266	Passa muros Liner com rosca - 860052	11,00 €



Boquilha de impulsão

28,1190	Boquilha de impulsão p/betão - 86008	11,50 €
28,1191	Boquilha de aspiração p/betão - 86007	7,00 €
28,1192	Boquilha de impulsão p/Liner - 86009	28,00 €
28,1193	Boquilha de aspiração p/Liner - 86176	25,00 €



Projetores

28,1195	Projetor completo p/betão - 86016	124,00 €
28,1196	Projetor completo p/Liner - 86875	134,00 €
28,1197	Projetor plano completo p/betão - 86989	113,00 €
28,1198	Projetor plano completo p/liner - 86990	129,00 €
28,1146	Lâmpada 300W - 12V - 86879	27,00 €
28,1194	Lâmpada LED BCO 18W - 86894	138,00 €
28,1267	Lâmpada LED RGB c/comando 18W - 86895	299,00 €
28,1129	Caixa de ligação - 86481	21,50 €



Escadas Muro

Código	Designação	Preço
28,1131	Escada muro 3 degraus - 87006	233,50 €
28,1132	Escada muro 4 degraus - 87007	266,00 €
28,1135	Escada muro 3 degraus - inox 316 - 87033	315,50 €
28,1136	Escada muro 4 degraus - inox 316 - 87034	363,00 €



Escadas Standart

Código	Designação	Preço
28,1138	Escada muro 3 degraus - 87002	233,50 €
28,1139	Escada muro 4 degraus - 87003	266,00 €
28,1141	Escada muro 3 degraus - inox 316 - 87017	315,50 €
28,1142	Escada muro 4 degraus - inox 316 - 87018	363,00 €



Duches

28,1076	Duche c/lava pés - 87022	259,50 €
28,1159	Duche simples - 87009	243,00 €

Válvula Seletora

28,1182	Válvula 6 vias completa - 1.½" - 84985	145,00 €
28,1184	Válvula 6 vias completa - 2" - 84986	145,00 €

Nota: Esta tabela pode ser alterada sem aviso prévio, preços sujeitos à taxa de I.v.a. em vigor.
 Setúbal, 01 de Janeiro de 2018.

Artigos de Piscina

Artigos limpeza para Piscina

Código	Designação	Preço
28,1210	Mangueira flutuante c/boquilhas 8 mts	35,73 €
28,1211	Mangueira flutuante c/boquilhas 10 mts	42,64 €
28,1212	Mangueira flutuante c/boquilhas 12 mts	48,91 €
28,1213	Mangueira flutuante c/boquilhas 30 mts	103,93 €
28,1150	Limpa fundos flexível c/escova	28,71 €
28,1015	Limpa fundos flexível	21,32 €
28,1020	Apanha folhas plano	10,82 €
28,1147	Apanha folhas bolsa	12,80 €
28,1151	Haste extensível 3,60 mts	23,57 €
28,1152	Haste extensível 5,00 mts	28,71 €
28,1220	Escova limpa paredes reforçada	11,19 €
28,1221	Kit acessórios limpeza	40,18 €
28,1222	Doseador flutuante	4,45 €
28,1154	Termómetro	6,38 €
28,1108	Manómetro de pressão	13,00 €
28,1102	Teste digital	84,64 €
28,1103	Recargas 50 tiras	11,25 €
28,1226	Estojo analisador de CL total e PH	10,13 €
28,1227	Recarga analisador de CL e PH (unid.)	3,70 €
28,1260	Teste Aquacheck amarelo	10,88 €
28,1262	Teste Aquacheck para sal 10 tiras	13,67 €
28,1228	Sal marinho granulado - saco 25 Kg (unid.)	14,90 €
28,1014	Areia grossa e fina para filtros (Kg)	0,52 €



Aspirador hidráulico para piscina

28,1231	Limpa fundos Automático Navigator PRO (Manómetro, filtro e Vac)	①	564,28 €
28,1253	Limpa fundos Typhoon 4	②	699,00 €
28,1254	Limpa fundos automático MX 9	③	742,86 €
28,1255	Limpa fundos automático TORNAX PRO RT 3200	④	1.097,00 €
28,1238	Limpa fundos automático Cyclonx Pro RC 4400	⑤	1.407,00 €
28,1239	Limpa fundos elétrico SharkVAC XL Pilot	⑥	1.500,00 €





Hidrosado, Lda.

Quinta Varzinha, Lote 25

2900-721 Setúbal

Telefone: 265537550

Fax: 265537551

Mail: geral@hidrosado.pt

Site: www.hidrosado.pt

Artigos de Piscina

Aparelhos de Sal - Eletrolisis - Just

Código	Designação	Preço
11,3140	Just Regul Uno Rx (160 m3/h)	746,43 €
11,3141	Just Regul Duo pH Rx (1 bomba - 160 m3/h)	1.266,67 €
11,3142	Just pH Pumping Progress	559,82 €



Bomba doseadora peristáltica MyPool

11,3150	Bomba doseadora Mypool pH	440,00 €
11,3151	Bomba doseadora Mypool Rx	468,80 €



Electrólise de Sal

11,3155	Clorador de Sal - 15g/h - 60 m3/h	878,50 €
11,3156	Clorador de Sal - 25g/h - 90 m3/h	950,00 €
11,3157	Clorador de Sal - 35g/h - 120 m3/h	1.102,00 €



Electrobomba doseadora

11,3160	Electrobomba doseadora peristáltica 1 l/h - 3 Bar	146,66 €
11,3161	Electrobomba doseadora peristáltica 6 l/h - 1 Bar	146,66 €



11,3165	Electrodo pH	86,66 €
---------	--------------	---------



Quadro piscina s/interruptor diferencial - WEG c/contactor disjuntor + relógio + disj. Magnético

11,3145	Quadro s/inter. Dif. 110H4 - 1,8 - 12,5 Amp - 230 V	182,61 €
11,3146	Quadro s/inter. Dif. 110H4 - 1,8 - 12,5 Amp - 400V	191,90 €



Quadro para piscina c/interruptor diferencial - P11 DH4 W.02

11,3147	Quadro c/inter. Dif. P11 DH4 W.02 - 1,8 - 12,5 Amp - 230V	213,57 €
11,3148	Quadro c/inter. Dif. P11 DH4 W.02 - 1,8 - 12,5 Amp - 400V	232,14 €



Quadro piscina c/comando para projetor + controlador Sal/PH

11,3145	Quadro c/projector + Controlador P233D - 1,6 - 10,0 Amp - 230V	229,00 €
11,3146	Quadro c/projector + Controlador P233D - 1,6 - 10,0 Amp - 400V	247,61 €



Quadro piscina c/1 Interruptor Horário e Interruptor Diferencial + Comando p/transformadores p/projetor + controlador Sal/PH

11,3135	Quadro c/ 1 IH+ID+CC+C/transf P32470 - 1,6 - 10 Amp - 230V	331,19 €
11,3136	Quadro c/ 1 IH+ID+CC+C/transf P32470 - 1,6 - 10 Amp - 400V	349,76 €



Quadro piscina c/1 Interruptor Horário e Interruptor Diferencial + 1 transformador 100VA p/projetor + controlador Sal/PH

11,3137	Quadro c/ 1 IH+ID+CC+C/transf P32471 - 1,6 - 10 Amp - 230V	424,00 €
11,3138	Quadro c/ 1 IH+ID+CC+C/transf P32471 - 1,6 - 10 Amp - 400V	442,61 €



Quadro piscina c/1 Interruptor Horário e Interruptor Diferencial + 1 transformador 300VA p/projetor + controlador Sal/PH

11,3125	Quadro c/1 IH+ID+CC+ 1 transf P32473 - 1,6 - 10 Amp - 230V	455,00 €
11,3126	Quadro c/1 IH+ID+CC+ 1 transf P32473 - 1,6 - 10 Amp - 400V	473,67 €



Quadro piscina c/1 Interruptor Horário e Interruptor Diferencial + 2 transformadores 300VA p/projetor + controlador Sal/PH

11,3127	Quadro c/ 1 IH+ID+CC+ 2 transf P32476 - 1,6 - 10 Amp - 230V	563,33 €
11,3128	Quadro c/ 1 IH+ID+CC+ 2 transf P32476 - 1,6 - 10 Amp - 400V	581,90 €



Quadro piscina c/transformador

11,3070	Quadro c/ 1 transformador 300VA PTRAF	179,52 €
11,3079	Quadro c/ 2 transformador 300VA PTRAF	297,14 €



Nota: Esta tabela pode ser alterada sem aviso prévio, preços sujeitos à taxa de I.v.a. em vigor.
Setúbal, 01 de Janeiro de 2018.



Hidrosado, Lda.
 Quinta Varzinha, Lote 25
 2900-721 Setúbal
 Telefone: 265537550
 Fax: 265537551
 Mail: geral@hidrosado.pt
 Site: www.hidrosado.pt

Artigos de Piscina

Produtos Tratamento de Piscina

Código	Designação	Preço
28,1043	Balde 5 Kg c/pastilhas de cloro - 200 gr - 5 ações	35,00 €
28,1176	Balde 25 Kg c/pastilhas de cloro - 200 gr - 5 ações	162,00 €
28,1235	Balde 5 Kg c/pastilhas de cloro - 200 gr - 3 ações	33,21 €
28,1236	Doseador 1 kg 3 ações	25,34 €
28,1052	Balde 5 Kg Cloro Granulado - Cloro de Choque - ação rápida	29,73 €
28,1157	Balde 25 Kg Cloro Granulado - Cloro de Choque - ação rápida	133,93 €
28,1242	Cloro em grão 5 Kg	31,60 €
28,1243	Cloro em pó 5 Kg	37,77 €
28,1244	Cloro T200 5 Kg	32,68 €
28,1245	Cloro T200 25 Kg	147,32 €
28,1246	Cloro rápido T 20gr	41,79 €
28,1013	Balde 1 Kg Oxygen Shock	22,90 €
28,1247	Balde 5 Lts Oxygen ativo liquido	26,51 €
28,1248	Balde 20 Lts Oxygeno ativo liquido	64,29 €
28,1093	Balde 5 kg Bromo T 100	98,30 €
28,1168	Balde 25 Kg Hipoclorito sódio	30,80 €
28,1249	Balde 5 Lts Anti-Algas - dupla concentração abrilhantador	13,13 €
28,1250	Balde 25 Lts Anti-Algas - dupla concentração abrilhantador	60,27 €
28,1251	Balde 5 Lts Anti-algas tripla ação	21,16 €
28,1252	Kit minipiscinas	15,21 €
28,1166	Balde 5 Lts ácido clorídrico	10,90 €
28,1171	Balde pH(-) - 8 Kg - Grão	20,14 €
28,1099	Balde pH(-) - 40 Kg - Grão	96,43 €
28,1095	Balde pH(-) - 20 Lts - Liquido	32,14 €
28,1170	Balde pH(+) - 5 Kg - Grão	13,13 €
28,1100	Balde pH(+) - 30 Kg - Grão	70,71 €
28,1096	Balde pH(+) - 20 Lts - Liquido	32,14 €
28,1064	Balde 5 Lts Anti-Algas - Invernada	30,00 €
28,1046	Doseador 2 Kg Invernada	23,52 €
28,1056	Balde 5 Lts Floculante	13,39 €
28,1169	Balde 25 Lts Floculante	60,27 €
28,1174	Balde 5Kg Floculante Clarificador	22,23 €
28,1057	Balde 5 Lts Anti - Calcário	68,30 €
28,1177	Balde 5 Kg Incementador Alcalinidade	18,44 €



Nota: Esta tabela pode ser alterada sem aviso prévio, preços sujeitos à taxa de I.v.a. em vigor.
 Setúbal, 01 de Janeiro de 2018.

Produtos Tratamento de Piscina

Código	Designação do Produto	Embalagem	Preço
Corretores pH (Redução/aumento do pH da água)			
28,1300	CTX-10 - PH (-) pó	8 kg	20,80 €
28,1301	CTX-10 - PH (-) pó	40 kg	96,00 €
28,1302	CTX-15 - PH (-) Líquido	25 Lt	37,50 €
28,1303	CTX-20 - PH (+) pó	6 kg	15,30 €
28,1304	CTX-20 - PH (+) pó	35 kg	78,75 €
28,1305	CTX-25 - PH (+) Líquido	25 Kg	37,50 €
Desinfetantes			
28,1310	CTX-120 - Hipoclorito granulado	5 Kg	36,00 €
28,1311	CTX-120 - Hipoclorito granulado	45 Kg	249,75 €
28,1312	CTX-130 - Bromo	5 Kg	101,75 €
28,1313	CTX-132 - Multibromo 5 ações	5 Kg	102,50 €
28,1314	CTX-161 - Hipoclorito líquido	30 Lt	30,00 €
28,1315	CTX-200/gr - Cloro Shock	5 Kg	29,75 €
28,1316	CTX-200/gr - Cloro Shock	25 Kg	131,25 €
28,1317	CTX-200/gr - Cloro Shock	50 Kg	255,00 €
28,1318	CTX-300/gr - Tricloro granulado	5 Kg	37,00 €
28,1319	CTX-300/gr - Tricloro granulado	25 Kg	148,75 €
28,1320	CTX-300/gr - Tricloro granulado	50 Kg	295,00 €
28,1321	CTX-370 Emb. Quad - Cloro 250gr	5 Kg	37,25 €
28,1322	CTX-370 - Cloro 250gr	25 Kg	172,50 €
28,1323	CTX-392 Emb. Quad. - Cloro multiação	5 Kg	38,50 €
28,1324	CTX-392 - Cloro multiação	25 Kg	175,00 €
Algicidas			
28,1330	CTX-60 - Algicida abrillantador	5 lt	13,25 €
28,1331	CTX-60 - Algicida abrillantador	25 lt	60,00 €
28,1332	CTX-500 - Algicida alga stop	5 lt	12,50 €
28,1333	CTX-500 - Algicida alga stop	25 lt	56,25 €
28,1334	CTX-500/S - Algicida alga stop super	5 lt	17,75 €
28,1335	CTX-500/S - Algicida alga stop super	25 lt	78,75 €
28,1336	CTX-570 - Algicida alga stop s/espuma	5 lt	26,00 €
28,1337	CTX-570 - Algicida alga stop s/espuma	25 lt	127,50 €
Floculantes			
28,1340	CTX-41 - Floculante	5 lt	13,25 €
28,1341	CTX-41 - Floculante	25 lt	60,00 €
28,1342	CTX-42 - Floculante pastilha 100 gr	5 Kg	22,25 €
28,1343	CTX-42 - Floculante pastilha 100 gr	25 Kg	102,50 €
28,1344	CTX - Care Pods - 3 em 1	4 doses	29,80 €
28,1345	CTX-39 - Pastilha Floculante gel	1 Unid	4,51 €
Oxigénio			
28,1350	CTX-100 - Oxigénio pastilha	6 Kg	114,60 €
28,1351	CTX-100/gr - Oxigénio granulado	5 kg	97,80 €
28,1352	CTX-110 - Oxigénio Líquido	30 lt	121,50 €
28,1353	CTX-540 - Oxigénio Líquido	5 Lt	71,75 €
Complementos			
28,1360	CTX-75 - Desengordurante	5 Lt	18,50 €
28,1361	CTX-75 - Desengordurante	25 lt	67,50 €
28,1362	CTX-550 - Invernador	5 Lt	33,00 €
28,1363	CTX-235 - Sleepy Invernador com doseador flutuante incorporado	1 Unid	22,55 €
28,1364	CTX-21 - Incrementador Alcalinidade	6 Kg	19,80 €



Nota: Esta tabela pode ser alterada sem aviso prévio, preços sujeitos à taxa de I.v.a. em vigor.
 Setúbal, 01 de Janeiro de 2018.



Hidrosado, Lda.
 Quinta Varzinha, Lote 25
 2900-721 Setúbal
 Telefone: 265537550
 Fax: 265537551
 Mail: geral@hidrosado.pt
 Site: www.hidrosado.pt

Filtros Domésticos

Filtros Doméstico Pressão Máx. 8 bar

23,4033	Filtro Junior 5" x ¾" - Pequeno	18,50 €
23,4061	Filtro Junior 5" x 1" - Pequeno	18,50 €
23,4031	Vaso p/filtro 10" x ¾" - Grande	18,90 €
23,4032	Vaso p/filtro 10 x 1" - Grande	18,90 €
23,4048	Filtro Big/20-1"	121,42 €



Elementos Filtros Domésticos

23,4036	Elemento de filtro em algodão - 5" - Pequeno	2,30 €
23,4037	Elemento de filtro rede lavável - 5" - "	5,90 €
23,4062	Elemento de filtro em algodão - 10" - Grande	2,60 €
23,4063	Elemento de filtro rede lavável - 10" - "	7,90 €
23,4035	Elemento de filtro cerâmica p/bactérias - 10"	54,70 €
23,4043	Elemento de filtro carvão activo - 5"	8,70 €
23,4038	Elemento de filtro carvão activo - 10"	11,86 €
23,4039	Elemento de filtro INOX lavável - 10"	59,26 €
23,4064	Elemento c/Polifosfatos - 10"	24,03 €
23,4067	Elemento c/Polifosfatos - 5"	12,60 €
23,4042	Caixa de Polifosfato - 0,5 kg	14,10 €
23,4040	Caixa de Polifosfato - 1,5 kg	26,55 €
23,4029	Elemento misto algodão + carvão 10"	9,77 €
23,4049	Elemento Big 20"	28,57 €



Chave p/filtros domésticos

23,4034	Chave p/filtros domésticos	3,70 €
---------	----------------------------	--------



Filtros Doméstico Pressão Máx. 10 bar C/Manómetro, elemento inox, válvula descarga

16,1201	Filtro FT002	¾"	145272	140,00 €
---------	--------------	----	--------	----------



Filtros Domésticos - Grandes caudais

16,1205	Filtro de água NW 25	1"	11000 l/h	131,00 €
16,1206	Filtro de água NW 32	1.¼"	13.000 l/h	183,00 €
16,1207	Filtro de água NW 500	2"	40.000 l/h	597,00 €



Filtros de impureza em latão em Y

12,1210	Filtro em latão Y ¾"	8,73 €
12,1211	Filtro em latão Y 1"	8,73 €
12,1212	Filtro em latão Y 1.¼"	17,27 €
12,1213	Filtro em latão Y 1.½"	21,76 €
12,1214	Filtro em latão Y 2"	37,34 €
12,1215	Filtro em latão Y 2.½"	78,38 €
12,1216	Filtro em latão Y 3"	91,55 €



Nota: Esta tabela pode ser alterada sem aviso prévio, preços sujeitos à taxa de I.v.a. em vigor.
 Setúbal, 01 de Janeiro de 2018.

Bombas Dosificadoras e Depósitos



Bomba Dosificadora Série - VCL

Código	Modelo	Pressão (bar)	Caudal (l/h)	Caudal por injeção	Tubo m/m	Preço
31.1024	VCL	10	10	0,93	4 x 6	450,00 €
31.1025	VCL	0,7	0,6	0,56	4 x 6	353,93 €

Bomba Dosificadora Série - VCO - c/reg.caudal

Código	Modelo	Pressão (bar)	Caudal (l/h)	Caudal por injeção	Tubo m/m	Preço
31.1026	VCO	18	0,2	0,19	4 x 6	332,90 €
31.1029	VCO	10	10	0,93	4 x 6	282,90 €

Bomba Dosificadora Série - VMS - c/sinal digital

Código	Modelo	Pressão (bar)	Caudal (l/h)	Caudal por injeção	Tubo m/m	Preço
31.1032	VMS - MF	15	0,2	0,19	4 x 6	452,63 €
31.1033	VMS - MF	10	10	0,93	4 x 6	551,32 €

Esterilizador UV - Idrapur

Código	Modelo	Q.Máx. m³/h	Ligação	Potência (W)	Preço
31.1080	Idrapure UV-LC 405	1,2	¾" M	30	964,29 €
31.1081	Idrapure UV-LC 412	2,7	1" M	40	1.250,00 €
31.1082	Idrapure UV-LC 440	3,6	1.½" M	40	1.750,00 €
31.1083	Idrapure UV-LC 480	5,1	1.½" M	80	2.464,29 €
31.1084	Idrapure UV-LC 550	6	1.½" M	2x40	2.750,00 €
31.1085	Idrapure UV-LC 80/2	12	1.½" M	2x80	3.797,62 €

Descalcificação doméstica volumétrico electrónico

Código	Modelo	Q.Máx. m³/h	C.Sal Kgs	Ciclo regeneração	Preço
31.1090	Idrasoft-5600/10/SXT	0,8	2,0	3,0	1.047,60 €
31.1091	Idrasoft-5600/15/SXT	1,2	3,0	4,5	1.071,43 €
31.1092	Idrasoft-5600/20/SXT	1,6	4,0	6,0	1.095,23 €
31.1093	Idrasoft-5600/30/SXT	2,4	6,0	9,0	1.154,76 €

Acessórios para bombas dosificadoras

Código	Designação	Preço
31.1034	Lança de aspiração 3/8" - Alt. 45	128,93 €
31.1035	Válvula de aspiração 3/8"	26,32 €
31.1036	Válvula de impulsão 3/8"	27,63 €
31.1037	Tubo 4 x 6 (1 mts)	6,43 €
31.1095	Lâmpada UV-LV 80W	189,20 €

Depositos Dosificadores

Código	Modelo	Capacidade (Lts)	Dimensões (mm)			Preço
			Diâmetro (mm)	Altura (mm)	l. tampa (mm)	
31.1013	D-50	50	360	690	125	47,38 €
31.1014	D-120	100	480	725	125	98,68 €
31.1015	D-230	200	570	1010	125	122,38 €
31.1016	D-300	300	610	1170	125	148,68 €
31.1017	D-500	500	750	1320	220	243,42 €
31.1018	D-1250	1250	1130	1620	400	525,00 €

Filtros de Gravilha

Hidrociclones

Fertilizadores

Contadores de água



Código	Designação	Preço
--------	------------	-------

Filtros de aço Zincado

23,4041	Filtro aço zincado 60/5 L 2"	562,29 €
23,4005	Filtro aço zincado 80/10L 3"	600,00 €
23,4006	Filtro aço zincado 100/20L 4"	672,00 €
23,4051	Filtro aço zincado 120/30L 5"	696,00 €

Filtros de gravilha

23,4008	Filtro de areia de 2" metálico p/11m ³ - 22m ³	970,66 €
23,4009	Filtro de areia de 3" em aço zincado p/22m ³ - 43m ³	1.144,00 €
23,4010	Filtro de areia de 4" em aço zincado p/50m ³ - 72m ³	1.594,67 €

Hidrociclones

23,4007	Hidrociclones de 1.½" metálico p/16m ³	364,00 €
23,4011	Hidrociclones de 2" metálico p/25m ³	398,67 €
23,4012	Hidrociclones de 3" em aço zincado p/60m ³	541,33 €
23,4030	Hidrociclones de 4" em aço zincado p/80m ³	641,33 €

Fertilizadores de Adubo

23,4054	Injector Venturi - Ø 3mm - ¾" - 14 - 50L/h	37,89 €
23,4055	Injector Venturi - Ø 5mm - ¾" - 36 - 150L/h	37,89 €
23,4056	Injector Venturi - Ø 7mm - 1" - 33 - 300L/h	41,89 €

Agitador

23,4090	Agitador soprante 2 turbinas - 69,4 l/s - 3,1 hmt - 2 HP - 230V	262,55 €
23,4091	Agitador de pás 1,00 mts - 0,75 HP - 1000 rpm - 400V	529,65 €
23,4092	Agitador de pás 1,20 mts - 0,75 HP - 1000 rpm - 400V	529,65 €

Fertilizador eléctrico Série Seko Piston Inox

23,4095	Bomba injectora Seko 230V 110 l/h	867,42 €
23,4096	Bomba injectora Seko 400V 110 l/h	795,14 €
23,4097	Bomba injectora Seko 230V 220 l/h	1.065,42 €
23,4098	Bomba injectora Seko 400V 220 l/h	993,14 €

Contadores de Água

Contador de plástico



Código	Ø	Preço
31,1100	½"	43,23 €
31,1101	¾"	51,90 €
31,1102	1"	73,82 €
31,1103	1.¼"	126,81 €

Contador metal s/impulsos



Código	Ø	Preço
31,1105	½"	33,43 €
31,1106	¾"	55,71 €
31,1107	1"	86,67 €
31,1108	1.¼"	102,76 €
31,1109	1.½"	184,48 €
31,1110	2"	262,48 €

Contador metal c/impulsos



Código	Ø	Preço
31,1115	¾"	86,24 €
31,1116	1"	103,97 €
31,1117	1.¼"	190,30 €

Contador Woltman s/impulso

Código	Ø	Preço
31,1120	2" - DN50	287,60 €
31,1121	2.½" - DN65	306,30 €
31,1122	3" - DN80	347,00 €
31,1123	4" - DN100	398,00 €



Contador Woltman c/impulso

Código	Ø	Preço
31,1130	2" - DN50	324,72 €
31,1131	2.½" - DN65	343,33 €
31,1132	3" - DN80	384,18 €
31,1133	4" - DN100	435,20 €

Nota: Esta tabela pode ser alterada sem aviso prévio, preços sujeitos à taxa de I.v.a. em vigor.

Setúbal, 01 de Janeiro de 2018.



Hidrosado, Lda.

Quinta Varzinha, Lote 25

2900-721 Setúbal

Telefone: 265537550

Fax: 265537551

Mail: geral@hidrosado.pt

Site: www.hidrosado.pt

Filtros de Rega



Filtro PGT

Código	Modelo	Ø	Débito	Preço
23,4100	Filtro PGT - PN6	½"	4800 L/h	6,42 €
23,4101	Filtro PGT - PN6	¾"	4800 L/h	9,53 €
23,4102	Filtro PGT - PN6	1"	6600 L/h	13,23 €
23,4103	Filtro PGT - PN6	1.¼"	10500 L/h	14,44 €
23,4104	Filtro PGT - PN6	1.½"	10500 L/h	21,75 €
23,4105	Filtro PGT - PN6	2"	18000 L/h	35,96 €
23,4106	Filtro PGT - PN6	2.½" S	18000 L/h	37,30 €

Código	Modelo	Ø	Débito	Preço
23,4110	Elemento PGT	½"	4,8 m/h	4,42 €
23,4111	Elemento PGT	¾"	4,8 m/h	5,47 €
23,4112	Elemento PGT	1"	6,6 m/h	8,34 €
23,4113	Elemento PGT	1.¼"	10,5 m/h	8,59 €
23,4114	Elemento PGT	1.½"	10,5 m/h	12,29 €
23,4115	Elemento PGT	2"	18 m/h	20,05 €
23,4116	Elemento PGT	2.½" S	18 m/h	20,05 €

Filtro lamelas

Código	Modelo	Ø	Débito	Preço
23,4120	Filtro y PN	¾"	4800 L/h	9,24 €
23,4121	Filtro y PN	1"	6600 L/h	9,24 €
23,4122	Filtro y PN	1.¼"	10500 L/h	21,48 €
23,4123	Filtro y PN	1.½"	10500 L/h	21,48 €
23,4124	Filtro y PN10	2"	18000 L/h	33,26 €



Filtro ACQUA BRIDGE

Código	Modelo	Dimensão	Ligação	Preço
23,4130	Filtro Acqua Bridge 2" - 2 vias Referências em 150 mesh	Curto	BSP	138,00 €
23,4133		Longo	BSP	173,79 €
23,4136	Filtro Acqua Bridge 3" - 2 vias Referências em 150 mesh	Duplo Curto	BSP	255,75 €
23,4139		Duplo Longo	BSP	325,50 €

23,4145	Filtro Acqua Bridge 3" - 3 vias Referências em 150 mesh	Curto	BSP	143,87 €
23,4148		Longo	BSP	175,37 €
23,4151	Filtro Acqua Bridge 3" - 3 vias Referências em 150 mesh	Duplo Curto	BSP	253,72 €
23,4154		Duplo Longo	BSP	325,50 €



Nota: Esta tabela pode ser alterada sem aviso prévio, preços sujeitos à taxa de I.v.a. em vigor.

Setúbal, 01 de Janeiro de 2018.



Hidrosado, Lda.

Quinta Varzinha, Lote 25

2900-721 Setúbal

Telefone: 265537550

Fax: 265537551

Mail: geral@hidrosado.pt

Site: www.hidrosado.pt



Aspersores

Preço

08,110001	Asp. MARLUX 2 Bicos plástico 3/4"	R01	circular	4,13 €
08,110003	Asp. MARLUX 2 Bicos latão 3/4"	R03	circular	4,75 €
08,110006	Asp. MARLUX 1 Bicos plástico 1/2"	R06	circular	3,69 €
08,110007	Asp. MARLUX 1 Bicos plástico 3/4"	R07	circular	3,72 €
08,110011	Asp. MARLUX 1 Bicos plástico 1/2"	BAR11	sector	6,29 €
08,110012	Asp. MARLUX 1 Bicos plástico 3/4"	BAR12	sector	6,29 €
08,110013	Asp. MARLUX 1 Bico plástico 3/4"	SR 13	sector	6,29 €
08,110018	Asp. MARLUX 2 Bicos plástico 1"	R18	circular	6,50 €
08,110019	Asp. MARLUX 1 Bicos plástico 1"	SR19	sector	7,27 €
08,110022	Asp. MARLUX 2 Bicos plástico 1/2"	R22	circular	4,78 €

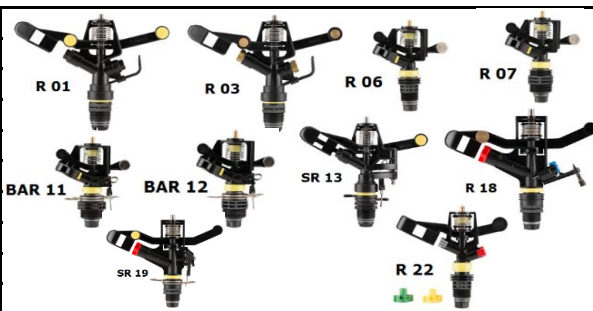

Tubos Suporte serie Axial

Tubos Suporte Extensivo

08,120001	15cm	1,79 €		08,120021	65 x 120	5,53 €	
08,120002	30cm	2,13 €		08,120022	85 x 160	6,51 €	
08,120003	60cm	2,84 €		08,120023	105 x 200	7,50 €	
08,120004	80cm	3,33 €		08,120024	130 x 250	11,96 €	
08,120005	100cm	3,78 €		08,120025	155 x 300	13,83 €	
08,120006	120cm	4,27 €					
08,120007	150cm	4,99 €					
08,120008	200cm	6,18 €					

Extensão PVC - 3/4"

Tripés Metálicos

08,120061	25cm	1,72 €		08,120071	1"	43,80 €	
08,120062	50cm	2,36 €		08,120074	1. 1/4"	96,40 €	
08,120063	75cm	3,00 €		08,120072	1. 1/2 "	101,64 €	
08,120064	100cm	3,64 €					
08,120065	125cm	4,28 €		<h3>Quadripé Metálicos</h3>			
08,120066	150cm	4,92 €		08,120069	1. 1/2 "	115,69 €	
08,120067	175cm	5,57 €		08,120073	2"	119,17 €	
08,120068	200cm	6,20 €					

Tomadas com sapata

Tomadas sem sapata

08,120075	50	7,63 €		08,120078	50	4,18 €	
08,120076	63	5,60 €		08,120079	63	3,42 €	
08,120077	71	5,60 €		08,120080	71	3,40 €	

Sapatas p/tomada

Boquilha

08,130031	50	1,90 €		08,190001	2"	1,00 €	
08,130032	63	1,90 €					
08,130033	71	1,90 €					

Espeto Plástico

Espeto Alumínio

08,350004	Tê	3,78 €		08,360002	Tê	7,30 €	
08,350003	Curvo	2,97 €		08,360001	Curvo	7,07 €	

Bebedouro plástico

Vedantes das juntas

351001	Simples	11,93 €		08,295003	Estreitos	0,31 €	
351002	C/ferragem	16,20 €		08,296304	Largos	0,58 €	

Ponteira sup.tubo suporte

Batente inf. Tubo suporte

08,280001		0,52 €		08,280011		0,65 €
08,354011	Bisnaga de cola	4,56 €		08,40360200	Parafuso c/porca M10	0,17 €
08,40223021	Oringues MX 50mm	0,42 €		08,40223031	Oringue MX 63 mm	0,50 €
08,40360101	Oringue da tomada(novo)	0,31 €		08,40360103	Oringue da tomada(Antigo)	0,34 €

Nota: Esta tabela pode ser alterada sem aviso prévio, preços sujeitos à taxa de I.v.a. em vigor.

Setúbal, 01 de Janeiro de 2018.

Pág.: 55



Hidrosado, Lda.
 Quinta Varzinha, Lote 25
 2900-721 Setúbal
 Telefone: 265537550
 Fax: 265537551
 Mail: geral@hidrosado.pt
 Site: www.hidrosado.pt



Junta Fêmea AX

08,140003	1.½ "	2,85 €
08,140004	2"	3,25 €
08,140005	2.½ "	3,84 €



Junta Macho AX

08,150002	1.½ "	1,27 €
08,150003	2"	2,40 €
08,150004	2.½ "	2,23 €



Junta F. AX c/Tomada

08,170002	1.½ "	9,36 €
08,170003	2"	8,62 €
08,170004	2.½ "	10,19 €



Junta F. c/tomad. P/colar

08,175003	1.½ "	6,55 €
08,176304	2"	6,42 €
08,177505	2.½ "	7,59 €



Tê entrada AX - Comum

08,210011		11,60 €
-----------	--	---------



Tê saída MX - Comum

08,190010		11,60 €
-----------	--	---------



Cruzeta AX - comum

08,210031		16,74 €
-----------	--	---------



União c/tomada AX

08,240001		9,80 €
-----------	--	--------



Curva de entrada AX - Comum

08,220011		12,99 €
-----------	--	---------



Mini-Tubo c/Tomad. AX - Comum

08,230011		9,94 €
-----------	--	--------



Tampão Terminal AX

08,200002		1,69 €
-----------	--	--------



Junta Fêmea c/roscas M - AX

08,213008	1.½ "	5,34 €
08,213009	2"	4,56 €



Junta M c/roscas F - AX

08,215008	1.½ "	5,05 €
08,215009	2"	5,54 €



Junta F c/roscas F - AX

08,213010	1.½ "	6,56 €
08,213011	2"	5,55 €



Junta M c/roscas M - AX

08,215006	1.½ "	9,36 €
08,215007	2"	8,62 €



Varas 6 mts AX c/Tomada

08,211001	1.½ "	25,22 €
08,211002	2"	27,57 €

Varas 6 mts AX s/Tomada

08,212001	1.½ "	20,25 €
08,212002	2"	22,35 €



Nota: Esta tabela pode ser alterada sem aviso prévio, preços sujeitos à taxa de I.v.a. em vigor.
 Setúbal, 01 de Janeiro de 2018.



Hidrosado, Lda.

Quinta Varzinha, Lote 25

2900-721 Setúbal

Telefone: 265537550

Fax: 265537551

Mail: geral@hidrosado.pt

Site: www.hidrosado.pt



Junta Fêmea MX

08,141003	1.½ "	2,87 €
08,141004	2"	2,82 €
08,141005	2.½ "	5,26 €
08,223006	3"	6,82 €
08,223007	4"	7,87 €



Junta Macho MX

08,151003	1.½ "	4,44 €
08,151004	2"	4,75 €
08,151005	2.½ "	8,25 €
08,225006	3"	9,97 €
08,225007	4"	10,33 €



Junta F. MX c/Tomada

08,171003	1.½ "	9,48 €
08,171004	2"	9,77 €
08,171005	2.½ "	10,18 €



Cruzeta MX

08,215030	1.½ "	14,12 €
08,216331	2"	16,34 €
08,217532	2.½ "	25,05 €
08,226023	3"	33,94 €



Tê entrada MX

08,226012	1.½ "	11,47 €
08,216311	2"	13,59 €
08,217513	2.½ "	19,72 €
08,226015	3"	27,62 €



Tê saída MX

08,215010	1.½ "	11,47 €
08,216312	2"	13,59 €
08,217514	2.½ "	19,72 €
08,226019	3"	27,33 €



Curva de entrada MX

08,227503	1.½ "	9,61 €
08,226304	2"	11,05 €
08,227505	2.½ "	16,74 €



Mini-Tubo c/Tomada MX

08,235003	1.½ "	11,98 €
08,236304	2"	12,62 €



Tampão Terminal MX

08,205003	1.½ "	4,19 €
08,206304	2"	4,75 €
08,207505	2.½ "	7,79 €
08,226004	3"	9,02 €



Junta Fêmea c/rosca M - MX

08,223017	1.½ "	3,95 €
08,223018	2"	5,01 €
08,223019	2.½ "	9,80 €
08,223020	3"	15,71 €



Junta F. c/Tomada p/colar

08,175004	1.½ "	
08,176305	2"	
08,177506	2.½ "	



Junta M p/colar MX

08,155003	1.½ "	3,38 €
08,156304	2"	3,86 €
08,157505	2.½ "	6,19 €
08,225014	3"	7,39 €



Junta M c/rosca M - MX

08,225015	1.½ "	6,06 €
08,225016	2"	6,98 €
08,225021	2.½ "	13,82 €
08,225022	3"	18,88 €



Junta M c/rosca F - MX

08,225017	1.½ "	5,66 €
08,225018	2"	6,33 €
08,225020	2.½ "	15,33 €



Varas 6 mts MX c/Tomada

08,221001	1.½ "	24,15 €
08,221002	2"	28,65 €
08,221003	2.½ "	50,29 €



Varas 6 mts MX s/Tomada

08,222001	1.½ "	18,94 €
08,222002	2"	22,86 €
08,222003	2.½ "	36,72 €



Nota: Esta tabela pode ser alterada sem aviso prévio, preços sujeitos à taxa de I.v.a. em vigor.
Setúbal, 01 de Janeiro de 2018.



Hidrosado, Lda.
 Quinta Varzinha, Lote 25
 2900-721 Setúbal
 Telefone: 265537550
 Fax: 265537551
 Mail: geral@hidrosado.pt
 Site: www.hidrosado.pt

Acessórios em V.D.

Código	Medida	Preço
--------	--------	-------

Curva VD 90°

10.1025	60 - 2"	35,20 €
10.1022	80 - 3"	47,53 €
10.1023	100 - 4"	61,84 €
10.1043	120 - 5"	88,38 €
10.1045	150 - 6"	116,84 €



Código	Medida	Preço
--------	--------	-------

Junções VD bola / rosca

10.1028	60 - 2"	18,23 €
10.1030	80 - 3"	24,62 €
10.1029	100 - 4"	32,83 €
10.1047	120 - 5"	42,60 €
10.1048	150 - 6"	53,15 €



Junções VD bola / mangueira

10.1009	60 - 2"	13,09 €
10.1010	80 - 3"	17,53 €
10.1015	100 - 4"	23,80 €
10.1016	120 - 5"	29,80 €
10.1017	150 - 6"	38,94 €
10.1018	200 - 8"	91,00 €



Válvulas Chupadoras mangueira

10.2058	60 - 2"	77,07 €
10.2059	80 - 3"	87,19 €
10.2060	100 - 4"	101,20 €
10.2061	120 - 5"	135,19 €
10.2062	150 - 6"	157,81 €
10.2063	200 - 8"	344,81 €



Junções VD fêmea / mangueira

10.1003	60 - 2"	18,07 €
10.1004	80 - 3"	21,89 €
10.1006	100 - 4"	25,67 €
10.1011	120 - 5"	31,28 €
10.1012	150 - 6"	41,98 €
10.1013	200 - 8"	102,37 €



Válvulas Chupadoras macho

10.2065	60 - 2"	85,25 €
10.2066	80 - 3"	95,95 €
10.2067	100 - 4"	110,25 €
10.2068	120 - 5"	158,73 €
10.2069	150 - 6"	188,83 €



Junções VD fêmea c/rosca

10.1050	60 - 2"	21,96 €
10.1051	80 - 3"	29,08 €
10.1052	100 - 4"	35,53 €
10.1056	120 - 5"	45,58 €
10.1057	150 - 6"	56,76 €



Oringues p/Junções VD

10.1038	60 - 2"	0,84 €
10.1039	80 - 3"	1,06 €
10.1040	100 - 4"	1,32 €
10.1041	120 - 5"	2,31 €
10.1042	150 - 6"	3,27 €
10.1046	200 - 8"	7,55 €



Tampão macho VD

10.1060	60 - 2"	7,66 €
10.1061	80 - 3"	10,04 €
10.1062	100 - 4"	12,47 €
10.1063	120 - 5"	16,54 €
10.1064	150 - 6"	22,66 €



Acoplamento M/F

10.1065	80 x 60	35,05 €
10.1066	100 x 80	43,67 €
10.1067	120 x 100	52,87 €



Acoplamento F/M

10.1070	80 x 60	34,72 €
10.1071	100 x 80	42,35 €
10.1072	120 x 100	50,34 €



Nota: Esta tabela pode ser alterada sem aviso prévio, preços sujeitos à taxa de I.v.a. em vigor.
 Setúbal, 01 de Janeiro de 2018.



Hidrosado, Lda.
 Quinta Varzinha, Lote 25
 2900-721 Setúbal
 Telefone: 265537550
 Fax: 265537551
 Mail: geral@hidrosado.pt
 Site: www.hidrosado.pt

Canhões de Rega e Tripés

Canhões de Rega

23,2008 PIPER 1" 37,74 €

Bico	Pressão	Capacidade	Raio	Área irrigada	Precipitação	
mm	ATM-kg cm ²	l/min	m ³ /h	m	m ²	mm/h
5	2	22	1.3	13.5	572	2.3
	3	27	1.6	15	706	2.2
	4	32	1.9	16.5	854	2.2
6.5	2	32	1.9	14.5	660	2.8
	3	39	2.3	16.5	854	2.6
	4	45	2.7	17.5	961	2.8
8	2	42	2.6	15	706	3.6
	3	52	3.1	17	907	3.4
	4	60	3.7	18.5	1074	3.4
10	2	71	4.3	16.5	855	5.0
	3	87	5.2	18.5	1074	4.8
	4	100	6.1	19.5	1193	5.1

Sector (1 bico)



23,2009 JENNY 1" 41,64 €

Bico	Pressão	Capacidade	Raio	Área irrigada	Precipitação	
mm	ATM-kg cm ²	l/min	m ³ /h	m	m ²	mm/h
4	2	54	3.2	15	706	4.5
	3	66	3.9	17	907	4.2
	4	77	4.6	18	1017	4.5
6.5	2	79	4.7	16.5	854	5.5
	3	96	5.7	18	1017	5.6
	4	112	6.7	19	1134	5.9
8	2	110	6.6	17	907	7.2
	3	134	8.0	19.5	1193	6.7
	4	156	9.3	21	1385	6.7

Sector (2 bicos)



23,2010 FALCON 1.¼" 55,50 €

Bico	Pressão	Capacidade	Raio	Área irrigada	Precipitação	
mm	ATM-kg cm ²	l/min	m ³ /h	m	m ²	mm/h
7.5	2	71	4.2	17.5	962	4.4
	3	87	5.2	19.5	1194	4.3
	4	100	6.0	21	1384	4.3
8	2	88	5.3	18	1017	5.2
	3	107	6.4	20	1256	5.0
	4	124	7.4	21.5	1451	5.0
10	2	130	7.8	21	1384	5.6
	3	151	9.0	22.5	1590	5.7
	4	170	10.2	23.5	1734	5.9
12	2	182	10.2	23.5	1734	6.3
	3	211	12.6	26	2123	5.9
	4	236	14.2	28	2461	5.8

Sector (1 bico)



23,2011 CRIS 1.¼" 59,94 €

Bico	Pressão	Capacidade	Raio	Área irrigada	Precipitação	
mm	ATM	l/min	m ³ /h	m	m ²	mm/h
7.5	2	71	4.2	17.5	962	4.4
	3	87	5.2	19.5	1194	4.3
	4	100	6.0	21	1384	4.3
8	2	88	5.3	18	1017	5.2
	3	107	6.4	20	1256	5.0
	4	124	7.4	21.5	1451	5.0
10	2	130	7.8	21	1384	5.6
	3	151	9.0	22.5	1590	5.7
	4	170	10.2	23.5	1734	5.9
12	2	182	10.2	23.5	1734	6.3
	3	211	12.6	26	2123	5.9
	4	236	14.2	28	2461	5.8

Sector (2 bicos)



23,2012 SUPER-CRIS 1.½" 68,82 €

Bico	Pressão	Capacidade	Raio	Área irrigada	Precipitação	
mm	ATM	l/min	m ³ /h	m	m ²	mm/h
7.5	2	71	4.2	17.5	962	4.4
	3	87	5.2	19.5	1194	4.3
	4	100	6.0	21	1384	4.3
8	2	88	5.3	18	1017	5.2
	3	107	6.4	20	1256	5.0
	4	124	7.4	21.5	1451	5.0
10	2	130	7.8	21	1384	5.6
	3	151	9.0	22.5	1590	5.7
	4	170	10.2	23.5	1734	5.9
12	2	182	10.2	23.5	1734	6.3
	3	211	12.6	26	2123	5.9
	4	236	14.2	28	2461	5.8

Sector (2 bicos)



23,2014 Garda 2" 180,00 €



Sector (2 bicos)

23,2013 Berico P4 1.½" 333,69 €

Bico	Pressão	Capacidade	Raio	Área irrigada	Precipitação	
mm	ATM-kg cm ²	l/min	m ³ /h	m	m ²	mm/h
12	2.5	150	9.0	22	1250	7.2
	3	158	9.5	23.5	1430	6.6
	3.5	171	10.3	25	1622	6.3
14	3	215	12.9	24.5	1560	8.2
	3.5	231	13.9	26	1756	7.9
	4	247	14.8	28	2036	7.2
16	3	280	16.8	26	1756	9.5
	3.5	303	18.2	28	2036	8.9
	4	324	19.4	29.5	2260	8.6
18	3.5	378	22.7	30.5	2416	9.3
	4	405	24.3	31	2496	9.7
	4.5	432	25.9	32	2660	9.7

Sector (1 bico)



Tripés

código	Ø	Preço
23,2075	1"	29,96 €
23,2076	1.¼"	61,00 €
23,2077	1.½"	65,00 €
24,2078	2"	84,00 €



Nota: Esta tabela pode ser alterada sem aviso prévio, preços sujeitos à taxa de I.v.a. em vigor.
 Setúbal, 01 de Janeiro de 2018.



Hidrosado, Lda.

Quinta Varzinha, Lote 25

2900-721 Setúbal

Telefone: 265537550

Fax: 265537551

Mail: geral@hidrosado.pt

Site: www.hidrosado.pt

Aspersão e Rega localizada



Código	Designação	Preço
23,2025	Aspersor LUFER latão 1/2" circular	12,00 €
23,2026	Aspersor LUFER latão 1/2" sector	23,00 €
23,2017	Aspersor LUFER latão 3/4" circular	18,50 €
23,2016	Aspersor LUFER latão 3/4" sector	28,42 €
23,2015	Aspersor LUFER latão 1" circular	21,50 €
23,2018	Aspersor LUFER latão 1" sector	31,00 €



Código	Artigo	°	Côr	Origem	Preço
23,3011	Nebulizador	360°	Vermelho	Marlux	1,02 €
23,3019	Micro/Aspersor	360°	Turbinete	Marlux	3,22 €
23,3134	Estaca metálica turbinete	Acessório	Turbinete	Marlux	1,58 €
23,3008	Micro/Aspersor	360°	Turbinete/completo	Marlux	7,35 €
23,3141	Acoplamento M/F	Acessório	Turbinete - Tubo 8mm	Marlux	0,33 €
23,3142	Tomada fêmea 8 mm	Acessório	Turbinete - Tubo 8mm	Marlux	0,15 €
23,3143	Tomada macho 8 mm	Acessório	Turbinete - Tubo 8mm	Marlux	0,21 €
23,3048	Aspersor R22	360°	Kit completo	Marlux	10,08 €
23,3121	ROCA 1/2"	360°	Varias	Nac.	1,25 €
23,3122	Aspersor Impacto 1/2"	sector	Laranja	Imp.	5,00 €



Código	Artigo	Preço
23,3180	Nebulizador 1 Coolnet Pro 5 l/h	1,17 €
23,3181	Nebulizador 2 Coolnet Pro Tê 5 l/h VR	2,15 €
23,3182	Nebulizador 4 Coolnet Pro 5 l/h	2,81 €



Código	Artigo	Preço
23,3190	Aspersor anti-insecto MegaNet 1/2" 350 l/h	4,58 €
23,3191	Deflector MegaNet	1,95 €
23,3192	Kit tubo + uniões 1/2"	2,36 €
23,3193	Estaca metálica 130cm x 8mm	2,00 €

Rega Hidroponia



Código	Artigo	Preço
23,3195	Kit adaptador + 1 tubo 60cm + 1 estaca condutora gotas	0,29 €
23,3196	Kit adaptador + 2 tubo 60cm + 2 estaca condutora gotas	0,77 €
23,3197	Kit adaptador + 4 tubo 60cm + 4 estaca condutora gotas	1,49 €

Nota: Esta tabela pode ser alterada sem aviso prévio, preços sujeitos à taxa de I.v.a. em vigor.
Setúbal, 01 de Janeiro de 2018.



Hidrosado, Lda.

Quinta Varzinha, Lote 25

2900-721 Setúbal

Telefone: 265537550

Fax: 265537551

Mail: geral@hidrosado.pt

Site: www.hidrosado.pt

Micro-regas

Código	Artigo	Preço
23,3042	Mini-União SAB - 4mm	0,07 €
23,3043	Mini-União SAB - 5mm	0,08 €
23,3046	Mini-União PRO - 4mm	0,07 €
23,3109	Mini-União PRO - 5mm	0,07 €
23,3102	Micro tampão SAB 3mm	0,05 €
23,3079	Micro tampão plástico - 4 mm	0,08 €
23,3128	Micro tê plástico - 4mm	0,08 €
23,3160	Micro tê plástico - 6mm	0,09 €
23,3129	Micro joelho plástico - 4mm	0,08 €
23,3161	Micro cruzeta plástico - 6mm	0,28 €
23,3163	Micro válvula 5mm	0,28 €



Mini uniões



Micro-válvula 6mm

23,3056	Estaca de Suspensão Plast. n/por.	0,28 €
23,3057	Estaca de Suspensão pequena MX	0,42 €
23,3050	Estaca Guia Mangueira 16 - 20	0,16 €



Estacas

Macarrão

23,3083	Tubo Macarrão 4/5 mm (metro)	0,31 €
23,3082	Tubo Macarrão 4/5 mm (kilo)	8,64 €

23,3124	Gotejador SAB DELTA - 4 L - (normal)	0,13 €
23,3165	Gotejador SAB Rambo - 2 L/H - normal - H/1	0,09 €
23,3166	Gotejador SAB Rambo - 4 L/H - normal - H/1	0,09 €
23,3167	Gotejador SAB Rambo - 8 L/H - normal - H/1	0,09 €
23,3168	Gotejador SAB Rambo - 15 L/H - normal - H/1	0,09 €
23,3169	Gotejador SAB Rambo - 2 L/H - (aut. comp.) - H/2	0,147 €
23,3170	Gotejador SAB Rambo - 4 L/H - (aut. comp.) - H/2	0,147 €
23,3171	Gotejador SAB Rambo - 8 L/H - (aut. comp.) - H/2	0,147 €
23,3172	Gotejador SAB Rambo - 15 L/H - (aut. comp.) - H/2	0,147 €
23,3052	Gotejador Marlux de 5 Saídas reg.	0,33 €
23,3123	Gotejador KATIF - 2 L - auto compensado.	0,30 €
23,3076	Gotejador KATIF - 4 L - auto compensado	0,30 €
23,3096	Gotejador regulável de grande caudal vermelho	0,12 €
23,3097	Gotejador regulável de grande caudal c/estaca	0,22 €
23,3068	Gotejador auto.comp. anti-drenante - GAL-E 2 L	0,23 €
23,3069	Gotejador auto.comp. anti-drenante - GAL-E 4 L	0,23 €



Delta

Rambo

Katif

Rambo a/c

5 saídas

Gotejador g/caudal

Gotejador g/caudal c/estaca

23,3074	Boquilha plast. 1/2" nacional	0,16 €
23,3103	Boquilha Plast. 1/2" SAB c/vedante borracha	0,18 €
23,3059	Canhão cônico c/vedante 1/2" n/pro.	0,24 €
23,3110	Vedante p/canhão cônico 1/2" n/pro.	0,12 €
23,3080	Tampão plástico macho 1/2" n/pro.	0,10 €
23,3127	Tampão plástico macho 5/8" n/pro.	0,16 €
23,3137	Anel fim de linha	0,06 €
23,3132	Abraçadeira p/vinha - 16 mm	0,054 €
23,3136	Abraçadeira p/vinha - Média	0,076 €
23,3139	Abraçadeira p/gota-a-gota	0,054 €
23,3133	Abraçadeira p/vinha - Longa SAB	0,089 €



anti-dreno

Boquilha SAB 1/2"

Canhão c/vedante 1/2"

Abraçadeira gota a gota

Anel fim de linha

Abraçadeira 16mm

Abraçadeira longa

23,3086	Furador 4 mm	8,90 €
23,3138	Alicate furador	20,37 €



Furador

Alicate furador

Nota: Esta tabela pode ser alterada sem aviso prévio, preços sujeitos à taxa de I.v.a. em vigor.
Setúbal, 01 de Janeiro de 2018.



Hidrosado, Lda.
 Quinta Varzinha, Lote 25
 2900-721 Setúbal
 Telefone: 265537550
 Fax: 265537551
 Mail: geral@hidrosado.pt
 Site: www.hidrosado.pt

Micro-regas

Código	Artigo	°	Côr	L/H	Origem	Preço
23,3150	Microjet	180°	Azul	25,6 - 57,3	Sab	0,20 €
23,3151	Microjet	180°	Verde	41,8 - 93,6	Sab	0,20 €
23,3152	Microjet	180°	Vermelho	57,4 - 127,9	Sab	0,20 €
23,3153	Microjet	180°	Laranja	64,0 - 152,0	Sab	0,20 €
23,3154	Microjet	180°	Cinza	80,0 - 165,0	Sab	0,20 €
23,3155	Microjet	180°	Branco	113,0 - 265,0	Sab	0,20 €
23,3156	Microjet	360°	Verde	41,8 - 93,6	Sab	0,20 €
23,3157	Microjet	360°	Laranja	64,0 - 152,0	Sab	0,20 €

23,3025	Microjet	180°	Castanho	60	N.P.	0,17 €
23,3026	Microjet	180°	Azul	75	N.P.	0,17 €
23,3027	Microjet	180°	Preto	100	N.P.	0,17 €
23,3028	Microjet	270°	Verde	90	N.P.	0,22 €
23,3029	Microjet	270°	Azul	80	N.P.	0,22 €
23,3034	Microjet	45x45	Amarelo	80	N.P.	0,22 €

Microjet 270 ° Anti-insecto

23,3092	Microjet	270°	Laranja	41	Int.	0,60 €
23,3093	Microjet	270°	Amarelo	52	Int.	0,60 €
23,3094	Microjet	270°	Cinza	100	Int.	0,60 €

23,3010	Microjet	360°	Violeta	45	Sab	0,66 €
23,3032	Microjet	360°	Amarelo	60	Sab	0,66 €
23,3033	Microjet	360°	Verde	110	Sab	0,66 €
23,3030	Microjet	360°	Azul	130	Sab	0,66 €
23,3125	Neblizador	360°	Preto/H10	90	Sab	0,24 €

23,3105	Micro/MX	360°	Vermelho	40	Nac.	0,798 €
23,2998	Micro/MX	360°	Amarelo	65	Nac.	0,798 €
23,2999	Micro/MX	360°	Azul	105	Nac.	0,798 €

Conjunto Microjet - Estaca, microtubo e adaptador

23,3117	MLK1VMS	90°	Vál.+jet	reg.	MX	2,69 €
23,3118	MLK2VMS	180°	Vál.+jet	reg.	MX	2,69 €
23,3119	MLF2VMS	360°	Vál.+jet	reg.	MX	2,69 €

Kit Elgo

23,2070	Kit Elgo Quickup					29,46 €
---------	------------------	--	--	--	--	---------

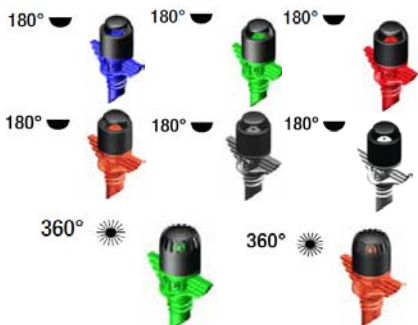

Microjet 180° - 270°



Microjet 270° Anti-insecto



Microjet 360°

Neblizador



Micro-Mx - 360°



Nota: Esta tabela pode ser alterada sem aviso prévio, preços sujeitos à taxa de I.v.a. em vigor.
 Setúbal, 01 de Janeiro de 2018.



Hidrosado, Lda.
 Quinta Varzinha, Lote 25
 2900-721 Setúbal
 Telefone: 265537550
 Fax: 265537551
 Mail: geral@hidrosado.pt
 Site: www.hidrosado.pt

Microjects e acessórios

Código	Artigo	°	Designação	I/h	Origem	Preço
23,2027	Microjet - 866	360°	Ein-Dor - Invertido	90	Pr	0,80 €
23,2028	"	360°	"	100	Pr	0,80 €
23,2029	"	360°	"	160	Pr	0,80 €
23,2030	Kit contrapeso 30 cm	-	4x7	-	Pr	0,90 €
23,2031	Kit contrapeso 60 cm	-	4x7	-	Pr	1,10 €
23,2032	Válvula anti-pingo	-	1,1 Bars	-	Pr	1,18 €
23,2033	Válvula anti-pingo	-	1,5 Bars	-	Pr	1,18 €
23,2034	Válvula anti-pingo	-	2,5 Bars	-	Pr	1,18 €
23,2035	Válvula anti-pingo	-	3,5 Bars	-	Pr	1,18 €
23,2036	Adaptador 4x7 macho	-	-	-	Pr	0,13 €
23,2037	Adaptador 4x7 Fêmea	-	-	-	Pr	0,13 €



Nebulizador Fogger

Código	Artigo	Preço
23,2080	Nebulizador Fogger 1 bico - 6 l/h	1,10 €
23,2081	Conexão Ein-Dor 2 vias - união F	0,17 €
23,2082	Conexão Ein-Dor 3 vias - Tê	0,17 €
23,2083	Cruzeta Fogger	0,80 €
23,2084	Tampão Fogger	0,18 €
23,2085	Regulador de pressão Ein-Dor	1,56 €



Casquilhos em plástico

26.1350	3/4" x 1/2" tubo	Adaptador para torneira	0,27 €
26.1370	1/2" x 1/2"	Casquilho duplo	0,18 €
26.1371	3/4" x 3/4"	"	0,25 €
26.1372	1" x 1"	"	0,54 €
26.1453	1.1/4" x 1.1/4"	"	0,66 €
26.1454	1.1/2" x 1.1/2"	"	0,74 €
26.1455	2" x 2"	"	1,65 €
26.1424	3/4" x 1/2"	Casquilhos redução	0,22 €
26.1425	1" x 3/4"	"	0,50 €



Canhões de plástico rôsca/macho

26.1435	Canhões	1/2"	0,18 €
26.1436	"	3/4"	0,27 €
26.1419	"	1"	0,34 €
26.1420	"	1.1/4"	0,46 €
26.1421	"	1.1/2"	1,62 €
26.1422	"	2"	1,96 €
26.1368	Canhão de redução	3/4" x 16	0,23 €
26.1369	"	3/4" x 20	0,24 €



Passa muros em plástico

26.1760	Passa muro	25 - 3/4"	2,17 €
26.1761	"	32 - 1"	2,92 €
26.1762	"	40 - 1.1/4"	4,52 €
26.1763	"	50 - 1.1/2"	6,00 €
26.1764	"	63 - 2"	7,71 €



Nota: Esta tabela pode ser alterada sem aviso prévio, preços sujeitos à taxa de I.v.a. em vigor.
 Setúbal, 01 de Janeiro de 2018.



Hidrosado, Lda.

Quinta Varzinha, Lote 25

2900-721 Setúbal

Telefone: 265537550

Fax: 265537551

Mail: geral@hidrosado.pt

Site: www.hidrosado.pt

Tube gotejador e Fita de Rega



Código	Artigo	Preço
--------	--------	-------

Tube Gotejador Introduzido 16mm - Rolo 400 mts

23,1060	Tube gotejador introduzido 0,33 x 0,33	0,292 €
23,1061	Tube gotejador introduzido 0,50 x 0,50	0,273 €
23,1062	Tube gotejador introduzido 0,75 x 0,75	0,247 €
23,1063	Tube gotejador introduzido 1,00 x 1,00	0,235 €

Tube Gotejador Introduzido 16mm - Rolo 100 mts

23,1065	Tube gotejador introduzido 0,33 x 0,33 - Castanho	0,394 €
23,1066	Tube gotejador introduzido 0,33 x 0,33 - Preto	0,286 €
23,1068	Tube gotejador introduzido 0,50 x 0,50 - Preto	0,274 €
23,1067	Tube gotejador introduzido 1,00 x 1,00 - Preto	0,243 €

Tube Gotejador Autocompensado 16mm - Rolo 400 mts

23,3088	Tube gotejador auto/comp. 0,33 x 0,33	0,522 €
23,3095	Tube gotejador auto/comp. 0,50 x 0,50	0,414 €
23,3089	Tube gotejador auto/comp. 0,75 x 0,75	0,344 €
23,3090	Tube gotejador auto/comp. 1,00 x 1,00	0,314 €

Tube Gotejador Autocompensado 16mm - Rolo 100 mts

23,1070	Tube gotejador auto/comp. 0,33 x 0,33 - Castanho	0,592 €
23,1071	Tube gotejador auto/comp. 0,33 x 0,33 - Preto	0,551 €
23,1069	Tube gotejador auto/comp. 0,50 x 0,50 - Preto	0,445 €
23,1072	Tube gotejador auto/comp. 1,00 x 1,00 - Preto	0,318 €

Fita Gotejadora 16mm 0,20 x 0,20

23,3550	Fita gotejadora 1,5 l/h - Rolo 100 mts	11,17 €
23,3551	Fita gotejadora 1,5 l/h - Rolo 200 mts	19,68 €
23,3552	Fita gotejadora 1,5 l/h - Rolo 450 mts	42,44 €
23,3553	Fita gotejadora 1,5 l/h - Rolo 1500 mts	117,00 €
23,3554	Fita gotejadora 1,5 l/h - Rolo 3000 mts	212,65 €
23,3530	Fita gotejadora Pastilha 8 Mil - 20 cm 1.10 l/h - 2400 mts	180,00 €

Tube Gotejador Super Compact 16mm - 1,0mm - 33cm x 33 cm

Código	Artigo	Preço
--------	--------	-------

23,1100	Tube gotejador Super-Compact - Rolo 25 mts	7,45 €
23,1101	Tube gotejador Super-Compact - Rolo 50 mts	13,90 €
23,1102	Tube gotejador Super-Compact - Rolo 100 mts	24,00 €
23,1103	Tube gotejador Super-Compact - Rolo 400 mts	86,40 €

Nota: Esta tabela pode ser alterada sem aviso prévio, preços sujeitos à taxa de I.v.a. em vigor.
Setúbal, 01 de Janeiro de 2018.



Hidrosado, Lda.

Quinta Varzinha, Lote 25

2900-721 Setúbal

Telefone: 265537550

Fax: 265537551

Mail: geral@hidrosado.pt

Site: www.hidrosado.pt

Válvulas hidráulicas

**Válvula HD s/solenóide 90°
s/regulador de caudal**



Código	Ø	Preço
16,1500	1"	14,78 €
16,1501	1.½"	45,43 €
16,1502	2"	54,57 €

**Válvula HD s/solenóide 180°
s/regulador de caudal**



Código	Ø	Preço
16,1505	1"	13,65 €
16,1506	1.½"	46,88 €
16,1507	2"	59,00 €

**Válvula HD s/solenóide 180°
M/M s/regulador de caudal**



Código	Ø	Preço
16,1510	3"	74,12 €

**Válvula metálica 180°
Rosca fêmea**



Código	Ø	Preço
16,1515	1"	58,90 €
16,1516	1.½"	60,89 €
16,1517	2"	67,98 €
16,1518	2.½"	109,91 €
16,1519	3"	175,00 €

**Válvula metálica 180°
Flangeada**



Código	Ø	Preço
16,1520	2" DN50	109,91 €
16,1521	3" DN80	185,46 €
16,1522	4" DN100	278,93 €
16,1523	6" DN150	682,49 €

**Autómato de comando
para 4 filtros**



Código	Ø	Preço
16,1525	ALPHA AL2	500,00 €

**Solenóide 3 vias G 75 24V AC
base plástico - 1,2mm**



Código	Tipo	Preço
16,1530	N/O	38,93 €
16,1531	N/C	38,93 €

**Piloto regulador plástico
0,5 - 5,5 bar**



Código	Ø	Preço
16,1550	4,5	149,55 €

**Piloto regulador metálico
0,5 - 5,5 bar**



Código	Ø	Preço
16,1555	2,5	192,87 €
16,1556	4,5	278,93 €

**Solenóide 3 vias GEM A 24V VAC
base metálica 1/8" - 2,4mm**



Código	Tipo	Preço
16,1535	N/O - 2,5W	71,31 €
16,1536	N/C - 2,5W	71,31 €
16,1537	N/O - 5,5W	58,94 €
16,1538	N/C - 5,5W	58,94 €

União Mista



Código	Ø	Preço
16,1560	1/8" x 6mm	1,64 €
16,1561	1/4" x 6mm	1,89 €

Curva 90°



Código	Ø	Preço
16,1565	1/8" x 6mm	2,12 €
16,1566	1/4" x 6mm	2,30 €

Tê misto rosca macho lateral



Código	Ø	Preço
16,1570	1/8" x 6mm	2,49 €
16,1571	1/8" x 8mm	3,00 €

Tê bocas iguais



Código	Ø	Preço
16,1575	6 x 6 x 6	3,00 €
16,1576	8 x 8 x 8	3,05 €

**Solenóide 3 vias G 75 230VAC
base plástico 1/8" - 1,6mm**



Código	Tipo	Preço
16,1540	N/O	58,94 €
16,1541	N/C	58,94 €

Casquilho duplo

Código	Ø	Preço
16,1580	1/8"	0,86 €
16,1581	1/4"	0,93 €



Micro tubo hidráulico (mt)

Código	Ø	Preço
16,1585	6mm	0,18 €
16,1586	8mm	0,26 €



Nota: Esta tabela pode ser alterada sem aviso prévio, preços sujeitos à taxa de I.v.a. em vigor.

Setúbal, 01 de Janeiro de 2018.

Pág.: 65



Hidrosado, Lda.
 Quinta Varzinha, Lote 25
 2900-721 Setúbal
 Telefone: 265537550
 Fax: 265537551
 Mail: geral@hidrosado.pt
 Site: www.hidrosado.pt

Electroválvulas

e

Programadores a pilhas



Código	Artigo	Preço
Electroválvulas SAFE RAIN		
16,1001	Electroválvula c/abertura manual AM 1" - 24V S/regulador caudal	18,61 €
16,1002	Electroválvula c/abertura manual AM 1" - 24V C/regulador caudal	20,13 €
16,1003	Electroválvula c/abertura manual 1.½" - 24v C/regulador caudal	49,35 €
16,1004	Electroválvula c/abertura manual 2" - 24v C/regulador caudal	54,80 €
16,1005	Electroválvula Baixa Pressão RPE - 11/4" - 8301BNPC24AC	54,50 €
16,1007	Electroválvula metálica 1" c/solenóide 230V	175,00 €
16,1010	Válvula s/solenóide - 1"	14,70 €
16,1011	Válvula s/solenóide - 1.½"	30,33 €
16,1012	Válvula s/solenóide - 2"	45,56 €
Solenóides e Transformadores		
16,1015	Solenóides p/electroválvulas - 24V	18,79 €
16,1016	Solenóides p/electroválvulas - 9V	16,77 €
16,1017	Transformador 230V - 20V - C/A 20 W	20,90 €
Programador Rain-Bird a pilhas 9V		
16,1110	Programador WP 1	115,48 €
16,1111	Programador WP 2	196,43 €
16,1112	Programador WP 4	209,00 €
16,1113	Programador WP 6	242,86 €
16,1114	Programador WP 8	277,38 €
16,1115	Solenóide impulsos 9V	45,24 €
16,1116	Adaptador para solenóide	8,93 €
Programador para torneira		
16,1025	Programador digital c/válvula para torneira ¾" - 9001 D	85,65 €
16,1026	Programador analógico c/válvula para torneira ¾" - 9001E	77,25 €
20.1305	Programador Galcon DC 1 - (61013)	140,00 €
23.1052	Válvula c/programador Galcon a pilhas - DC-1N - 1"	165,50 €
23.1053	Válvula c/programador Galcon a pilhas - DC-1N - 1,1/2"	259,00 €
23.1054	Válvula c/programador Galcon a pilhas - DC-1N - 2"	276,84 €
23,6014	Programador Galcon 4 estações - DC - 4	143,29 €
23,1026	Kit Programador DC - 4 + 2 válvulas DC 1"	239,77 €
23,6024	Programador Olympic	97,00 €
Programador Orbit a pilhas		
16,1030	Programador digital para torneira	70,53 €
16,1031	Programador HRC 990 - 4 Sectores	105,80 €
16,1032	Solenóide HRC	29,05 €

Nota: Esta tabela pode ser alterada sem aviso prévio, preços sujeitos à taxa de I.v.a. em vigor.
 Setúbal, 01 de Janeiro de 2018.



Hidrosado, Lda.
 Quinta Varzinha, Lote 25
 2900-721 Setúbal
 Telefone: 265537550
 Fax: 265537551
 Mail: geral@hidrosado.pt
 Site: www.hidrosado.pt

Programadores Eléctricos



Galcon



Código	Artigo	Preço
--------	--------	-------

Programador Orbit - Pocket Star Ultima

Programadores eléctricos c /transformador externo de 230v c/a a 24v dispõem de saída para arranque de bomba ou válvula mestra, para montagem interior, com dois programas independentes.

4 arraaques por cada (máximo 8 arraaques dia) tempo de rega por estação de 1 a 99 minutos

16,1035	Programador electrónico - 4 estações (Peq.) 24v	60,47 €
16,1036	Programador electrónico - 6 estações (Peq.) 24v	64,07 €



Programador ORBIT - Easy-Set - In/Out

Com ecrã LCD, tem 2 programas independentes com 4 inícios, pode programar até 8 regas por dia. Tempo de rega de 1 a 99 minutos. Dispõe de botão atraso de rega durante 24, 48 ou 72 horas em caso de chuva, quando ligado ao sensor.

Pode instalar-se ao ar livre, o transformador está instalado no interior, caixa resistente aos raios UV que protege do sol da chuva ou outras condições climáticas.

16,1037	Programador electrónico - 4 estações - 24v	139,07 €
16,1038	Programador electrónico - 6 estações - 24v	171,78 €
16,1039	Programador electrónico - 9 estações - 24v	204,93 €
16,1040	Programador electrónico - 12 estações - 24v	237,17 €



Programador electrónico GALCON AC 4 e AC 6 (24 V)

Programador com estações independentes 4 dias. Tempo de rega 1 a 12 horas, ciclo de rega semanal ou com intervalos de 1 a 30 dias. Programa interrupção de rega, arranque de bomba, auto protecção eléctrica, instalação interior, transformador incluído.

23,6020	Programador GALCON - AC - 4 - (4 estações)	119,00 €
23,6021	Programador GALCON - AC - 6 - (6 estações)	132,00 €
23,6022	Programador GALCON - AC - 6 S - (6 estações)	146,00 €



Sensor de Precipitação

23,6030	Sensor de Precipitação DX - 1	51,51 €
---------	-------------------------------	---------



Sensor de vento - Anemómetro

23,6032	Sensor de vento WIND CLICK	239,64 €
---------	----------------------------	----------

Nota: Esta tabela pode ser alterada sem aviso prévio, preços sujeitos à taxa de I.v.a. em vigor.
 Setúbal, 01 de Janeiro de 2018.



Hidrosado, Lda.

Quinta Varzinha, Lote 25

2900-721 Setúbal

Telefone: 265537550

Fax: 265537551

Mail: geral@hidrosado.pt

Site: www.hidrosado.pt

Espaços Verdes

Aspersores pulverizadores







Bicos difusor (plástico)

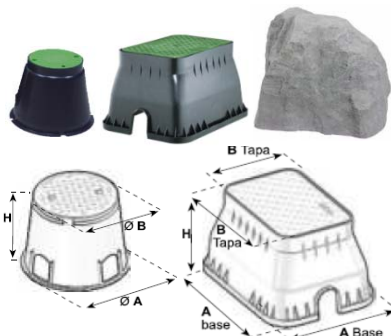

3222

3230



Código	Artigo	Preço
16,1050	Corpo difusor POP-UP 5 cm	3,50 €
16,1051	Corpo difusor POP-UP 10 cm	3,46 €
16,1052	Corpo difusor POP-UP 15 cm	10,75 €
16,1053	Corpo difusor POP-UP 30 cm	11,68 €
16,1049	Corpo difusor POP-UP 7,5 cm c/bico Regulável	4,83 €
16,1055	Corpo difusor K-Rain - RPS2 - KVF - 0,5cm - regulável	4,04 €
16,1056	Corpo difusor K-Rain - RPS4 - KVF - 10cm - regulável	4,32 €
16,1057	Bico difusor - 360° de 0 m a 4,5 m F15 c/filtro	1,43 €
16,1058	Bico difusor - 270° de 0 m a 4,5 m TQ15 c/filtro	1,43 €
16,1059	Bico difusor - 180° de 0 m a 4,5 m H15 c/filtro	1,43 €
16,1060	Bico difusor - 90° de 0 m a 4,5 m Q15 c/filtro	1,43 €
16,1061	Bico difusor rectângulo - central 	1,98 €
16,1062	Bico difusor rectângulo - central superior 	1,98 €
16,1063	Bico difusor rectângulo - lateral superior 	1,98 €
16,1064	Bico difusor regulável - 12° a 348°	1,98 €
16,1065	Adaptadores p/bicos aérios - plástico	0,90 €
16,1066	Adaptadores p/bicos aérios - latão	2,40 €

Aspersores de Rotor

23,2044	Aspersor ORBIT 5300	19,55 €
23,2045	Aspersor ORBIT 5500	23,41 €
23,2022	Aspersor ORBIT impacto satellite pop-up	23,32 €
23,2023	Aspersor K-RAIN turbina RPS 50 - ½"	15,58 €
23,2024	Aspersor K-RAIN turbina RPS 75 - ¾"	16,84 €

Aspersores Rain-Bird

16,1100	Corpo difusor Pop-Up - 5 cm - c/bico regulável - 15VAN - ½"	4,83 €
16,1101	Corpo difusor Pop-Up - 10 cm - c/bico regulável - 15VAN - ½"	4,83 €
16,1300	Aspersor Rain-Bird - série 3504 PC - ½"	15,58 €
16,1301	Aspersor Rain-Bird - série 5004 E-PC - ¾"	16,84 €

Caixa p/eletroválvulas

16,1074	Caixa redonda Baby	22 x 23 x 17	5,00 €
16,1075	Caixa redonda Júnior	32 x 26 x 24	10,26 €
16,1076	Caixa rectângular Sénior	55 x 40 x 31	24,21 €
16,1077	Caixa rectângular Maxí	66 x 50 x 32	50,15 €
16,1078	Caixa rocha decorativa	65 x 47,5 x 60	100,57 €
16,1103	Caixa redonda	H 20 x A 26 x B 16	6,37 €
16,1104	Caixa redonda	H 20 x A 30 x B 25	8,61 €
16,1107	Caixa rectangular	H 30 x A (49,6 x 38) x B (40 x 26,6)	26,85 €
16,1108	Caixa rectangular	H 30 x A (64 x 50) x B (52 x 37)	48,26 €

Nota: Esta tabela pode ser alterada sem aviso prévio, preços sujeitos à taxa de I.v.a. em vigor.

Setúbal, 01 de Janeiro de 2018.



Hidrosado, Lda.
 Quinta Varzinha, Lote 25
 2900-721 Setúbal
 Telefone: 265537550
 Fax: 265537551
 Mail: geral@hidrosado.pt
 Site: www.hidrosado.pt

Espaços Verdes

Hidrantes - Relva artificial



Código	Artigo	Preço
16,1082	Curva plástica - 16 mm c/roscas - 1/2"	0,46 €
16,1083	Curva plástica - 16 mm c/roscas - 3/4"	0,49 €
16,1084	Curva plástica - 25 mm c/roscas - 3/4"	0,62 €
16,1080	Hidrantes plástico - 1/2" 12,2 cm	0,65 €
16,1081	Hidrantes plástico - 3/4" 14,6 cm	0,70 €
16,1085	Tês plástico p/electroválvulas - 1"	3,57 €
16,1086	Curva p/electroválvulas - 1"	2,66 €
16,1087	Cruzeta p/electroválvula - 1"	3,89 €
16,1088	Junta m/f - p/electroválvula - 1"	2,00 €
16,1089	Tampão p/electroválvula - 1"	1,16 €



Hidrantes e Chaves diversas

16,1027	Hidrante em polietileno c/válvula rápida 3/4"	6,32 €
16,1028	Hidrante em polietileno c/válvula rápida 1"	6,32 €
16,1029	Chave p/hidrante c/válvula rápida	2,64 €
16,1090	Hidrante c/válvula - 3/4" c/tampa plast.c/fechadura	63,21 €
16,1091	Hidrante c/válvula - 3/4" c/tampa bronze s/fechadura	44,58 €
16,1092	Hidrante c/válvula - 3/4" c/tampa bronze c/fechadura	53,69 €
16,1093	Hidrante c/válvula - 1" c/tampa plast.c/fechadura	94,36 €
16,1094	Hidrante c/válvula - 1" c/tampa bronze s/fech.	70,90 €
16,1095	Hidrante c/válvula - 1" c/tampa bronze c/fech.	80,12 €
16,1096	Chave baioneta bronze - 3/4" macho x 1/2"	17,79 €
16,1097	Chave baioneta bronze - 1" macho x 3/4"	24,36 €
16,1098	Chave p/fecho - tampa hidrantes	4,16 €
16,1099	Codos de GIRO LOCO - 3/4" x 3/4"	20,55 €

Relva artificial



16,1120	Relva artificial TS Pro 50 m/m (m²)	21,430 €
16,1121	Relva artificial TS Dura 50 m/m (m²)	22,620 €

Acessórios para relva artificial



16,1130	Tela colagem rolo 100 mts (m²)	1,80 €
16,1131	Cola Indu PU 600 2K - 1 Kg	12,60 €
16,1132	Cola Indu PU 600 2K - 5 Kg	45,30 €

Nota: Esta tabela pode ser alterada sem aviso prévio, preços sujeitos à taxa de I.v.a. em vigor.
 Setúbal, 01 de Janeiro de 2018.

Acessórios de Plástico

Código	Medida	Preço
--------	--------	-------

Curvas de plástico 502 C

12.2011	1/2"	0,24 €
12.2080	5/8"	0,28 €
12.2012	3/4"	0,96 €
12.2027	1"	1,00 €
12.2013	1.1/4"	1,09 €
12.2028	1.1/2"	1,24 €
12.2029	2"	2,46 €



Unões de plástico 501

12.2004	1/2"	0,18 €
12.2006	5/8"	0,20 €
12.2005	3/4"	0,75 €
12.2007	1"	0,77 €
12.2037	1.1/4"	0,86 €
12.2008	1.1/2"	0,96 €
12.2009	2"	1,07 €



Tês de plástico 503

12.2016	1/2"	0,19 €
12.2052	5/8"	0,34 €
12.2048	3/4"	1,35 €
12.2017	1"	1,41 €
12.2031	1.1/4"	1,46 €
12.2018	1.1/2"	1,54 €
12.2019	2"	2,08 €



Unões de plástico acetal

12.2053	1.1/2"	1,16 €
12.2054	2"	1,84 €
12.2055	2.1/2"	2,84 €
12.2056	3"	3,78 €



Curvas com anel

12,2060	16 x 16	0,22 €
12,2061	20 x 20	0,25 €



Unões com anel

12,2062	16 x 16	0,24 €
12,2063	20 x 20	0,26 €



Boquilha c/anel

23,3100	1/2"	0,14 €
23,3101	5/8"	0,16 €



Código	Medida	Preço
--------	--------	-------

Tês de redução 503 R

12,2043	5/8" x 1/2"	0,52 €
12,2087	3/4" x 1/2"	0,69 €
12,2088	3/4" x 5/8"	0,72 €
12,2049	1" x 1/2"	1,39 €
12,2044	1" x 3/4"	1,16 €
12,2091	1.1/4" x 1/2"	1,41 €
12,2024	1.1/4" x 3/4"	1,18 €
12,2023	1.1/4" x 1"	1,18 €
12,2026	1.1/2" x 3/4"	1,41 €
12,2022	1.1/2" x 1"	1,50 €
12,2041	1.1/2" x 1.1/4"	1,34 €
12,2025	2" x 3/4"	1,91 €
12,2039	2" x 1"	1,91 €
12,2021	2" x 1.1/2"	1,70 €



Unões de redução 501 R

12,2057	5/8" x 1/2"	0,29 €
12,2093	3/4" x 1/2"	0,38 €
12,2094	3/4" x 5/8"	0,38 €
12,2096	1" x 5/8"	0,75 €
12,2046	1" x 3/4"	0,75 €
12,2097	1.1/4" x 1/2"	0,75 €
12,2059	1.1/4" x 3/4"	0,77 €
12,2036	1.1/4" x 1"	0,77 €
12,2078	1.1/2" x 1/2"	0,86 €
12,2099	1.1/2" x 5/8"	0,86 €
12,2000	1.1/2" x 3/4"	0,86 €
12,2032	1.1/2" x 1"	0,86 €
12,2003	1.1/2" x 1.1/4"	0,86 €
12,2100	2" x 1/2"	1,29 €
12,2001	2" x 3/4"	1,29 €
12,2098	2" x 1"	1,29 €
12,2045	2" x 1.1/4"	1,29 €
12,2002	2" x 1.1/2"	1,29 €



Cruzetas com anel

12,2066	16 x 16	0,61 €
12,2067	20 x 20	0,63 €



Tês com anel

12,2064	16 x 16	0,25 €
12,2065	20 x 20	0,30 €



Curva plástica c/anel

12,2070	16 x 1/2"	0,35 €
---------	-----------	--------



Torneira c/anel Tubo - Tubo

26,1427	16 x 16	0,72 €
26,1428	20 x 20	0,76 €





Hidrosado, Lda.

Quinta Varzinha, Lote 25

2900-721 Setúbal

Telephone: 265537550

Fax: 265537551

Mail: geral@hidrosado.pt

Site: www.hidrosado.pt

Mini-Válvulas

SAB

Válvula Tubo - Tubo



Código	Ø	Preço
26,1300	16 x 16	0,447 €
26,1304	20 x 20	0,474 €

Válvula Tubo - Boquilha



Código	Ø	Preço
26,1301	16	0,500 €
26,1306	20	0,526 €

Válvula Boquilha - Fita



Código	Ø	Preço
26,1308	16	0,553 €

Válvula Rosca - Tubo



Código	Ø	Preço
26,1309	16 x 1/2"	0,447 €
26,1310	16 x 3/4"	0,474 €
26,1320	20 x 1/2"	0,474 €
26,1311	20 x 3/4"	0,500 €
26,1312	25 x 3/4"	0,526 €

Válvula Rosca - Fita



Código	Ø	Preço
26,1321	16 x 1/2"	0,526 €
26,1322	16 x 3/4"	0,526 €

Válvula Tubo - Fita



Código	Ø	Preço
26,1314	16	0,500 €

Válvula Fita - Fita



Código	Ø	Preço
26,1302	16	1,110 €

Válvula Manga - Fita



Código	Ø	Preço
26,13232	16	0,526 €

Válvula Tubo - Rosca Fêmea



Código	Ø	Preço
26,1366	16 x 3/4"	0,95 €
26,1367	20 x 3/4"	0,95 €

Válvula Fita - Rosca Fêmea



Código	Ø	Preço
26,1401	16 x 3/4"	1,09 €

Válvula Rosca Fêmea - Macho



Código	Ø	Preço
26,1402	3/4" x 16	0,96 €

Válvula Rosca Fêmea - Fêmea



Código	Ø	Preço
26,1473	1" x 1"	1,47 €

Nota: Esta tabela pode ser alterada sem aviso prévio, preços sujeitos à taxa de I.v.a. em vigor.
Setúbal, 01 de Janeiro de 2018.



Hidrosado, Lda.

Quinta Varzinha, Lote 25

2900-721 Setúbal

Telefone: 265537550

Fax: 265537551

Mail: geral@hidrosado.pt

Site: www.hidrosado.pt

Artigos Fita e Manga



União Fita - Fita



Código	Ø	Preço
26,1408	-	0,21 €

Boquilha para tripa



Código	Ø	Preço
26,1410	16	0,23 €

Adaptador Tubo - Fita



Código	Ø	Preço
26,1360	16 x 16	0,19 €

Curva Fita - Fita



Código	Ø	Preço
26,1347	16	0,58 €

Tê Fita - Fita



Código	Ø	Preço
26,1348	16	0,73 €

Record Fita - manga



Código	Ø	Preço
26,1361	16	0,263 €

Adaptador para Manga



Código	Ø	Preço
26,13230	16	0,158 €

Record completo para Manga



Código	Ø	Preço
26,13231	16	0,42 €

Record Fita - Rosca macho



Código	Ø	Preço
26,1363	16 x 1/2"	0,263 €

Adaptador F/F para manga



Código	Ø	Preço
26,1364	16 x 1/2"	0,158 €

Tampão para Manga



Código	Ø	Preço
26,1365	16	0,30 €

Alicate para Manga



Código	Ø	Preço
23,3140	-	69,95 €

Chave para Manga



Código	Ø	Preço
26,1359	-	5,00 €

**Ventosa duplo efeito c/mola
compressão para Fita - Verde**



Código	Ø	Preço
26,1388	1/2"	0,61 €

**Ventosa duplo efeito c/mola
compressão para Tubo - Azul**



Código	Ø	Preço
26,1387	1/2"	0,61 €

Nota: Esta tabela pode ser alterada sem aviso prévio, preços sujeitos à taxa de I.v.a. em vigor.
Setúbal, 01 de Janeiro de 2018.



Hidrosado, Lda.

Quinta Varzinha, Lote 25

2900-721 Setúbal

Telefone: 265537550

Fax: 265537551

Mail: geral@hidrosado.pt

Site: www.hidrosado.pt

Acessórios de aperto rápido



	Código	Medida	Designação	Preço
	Uniões plást. rápid.mang./mang.			Artº 105
	26.1131	16 x 16	União acopl. rápido	1,245 €
	26.1132	20 x 20	"	1,235 €
	26.1133	25 x 25	"	1,430 €
	26.1134	32 x 32	"	1,830 €
	26.1135	40 x 40	"	3,300 €
	26.1136	50 x 50	"	4,500 €
	26.1137	63 x 63	"	6,240 €
	26.1138	75 x 75	"	12,440 €
	26.1139	90 x 90	"	15,620 €
	26.1411	110 x 110	"	32,735 €
	Record plástico rosca/mangueira			Artº 95
	26.1068	16 x 1/2"	Record plástico	0,835 €
	26.1069	16 x 3/4"	"	0,835 €
	26.1070	20 x 1/2"	"	0,690 €
	26.1071	20 x 3/4"	"	0,690 €
	26.1072	25 x 1/2"	"	0,795 €
	26.1073	25 x 3/4"	"	0,795 €
	26.1074	25 x 1"	"	0,820 €
	26.1075	32 x 1/2"	"	1,465 €
	26.1076	32 x 3/4"	"	1,005 €
	26.1077	32 x 1"	"	1,005 €
	26.1078	32 x 1.1/4"	"	1,440 €
	26.1079	40 x 1"	"	2,045 €
	26.1080	40 x 1.1/4"	"	2,045 €
	26.1081	40 x 1.1/2"	"	2,045 €
	26.1083	50 x 1.1/4"	"	2,750 €
	26.1084	50 x 1.1/2"	"	2,750 €
	26.1085	50 x 2"	"	2,805 €
	26.1086	63 x 1.1/4"	"	5,000 €
	26.1087	63 x 1.1/2"	"	3,805 €
	26.1088	63 x 2"	"	3,805 €
	26.1412	63 x 2.1/2"	"	5,000 €
	26.1413	75 x 2"	"	8,045 €
26,1474	75 x 2.1/2"	"	8,045 €	
26,1089	75 x 3"	"	8,370 €	
26.1440	90 x 2"	"	11,735 €	
26,1469	90 x 2.1/2"	"	9,540 €	
26,1468	90 x 3"	"	9,540 €	
26.1475	110 x 3"	"	18,610 €	
26.1403	110 x 4"	"	18,615 €	
	Tampões plásticos fim de linha			Artº 115
	26.1159	16mm	Tampão	0,905 €
	26.1160	20mm	"	0,890 €
	26.1161	25mm	"	0,930 €
	26.1162	32mm	"	1,140 €
	26.1163	40mm	"	2,030 €
	26.1164	50mm	"	3,000 €
	26.1165	63mm	"	4,070 €
	26.1166	75mm	"	10,425 €
	26.1167	90mm	"	11,660 €
	26.1168	110mm	"	25,255 €

Nota: Esta tabela pode ser alterada sem aviso prévio, preços sujeitos à taxa de I.v.a. em vigor.
Setúbal, 01 de Janeiro de 2018.



Hidrosado, Lda.
 Quinta Varzinha, Lote 25
 2900-721 Setúbal
 Telefone: 265537550
 Fax: 265537551
 Mail: geral@hidrosado.pt
 Site: www.hidrosado.pt

Acessórios de aperto rápido



	Código	Medida	Designação	Preço
Curvas em plástico 90°				Artº 120
	26.1169	16mm	Curvas de plástico	1,345 €
	26.1170	20mm	"	1,235 €
	26.1171	25mm	"	1,510 €
	26.1172	32mm	"	1,880 €
	26.1173	40mm	"	3,510 €
	26.1177	50mm	"	4,855 €
	26.1174	63mm	"	5,870 €
	26.1175	75mm	"	12,190 €
	26.1176	90mm	"	15,105 €
26.1415	110mm	"	31,335 €	
Unões de redução mang./mang.				Artº 110
	26.1142	20 x 16	União redução	1,750 €
	26.1145	25 x 16	"	1,850 €
	26.1143	25 x 20	"	1,420 €
	26.1144	32 x 20	"	2,490 €
	26.1452	32 x 25	"	1,860 €
	26.1373	40 x 25	"	3,205 €
	26.1147	40 x 32	"	3,205 €
	26.1487	50 x 25	"	4,155 €
	26.1374	50 x 32	"	4,155 €
	26.1150	50 x 40	"	4,155 €
	26.1375	63 x 32	"	7,685 €
	26.1376	63 x 40	"	5,895 €
	26.1153	63 x 50	"	5,895 €
	26.1416	75 x 50	"	11,315 €
	26.1154	75 x 63	"	11,315 €
	26.1417	90 x 63	"	14,965 €
26.1157	90 x 75	"	14,965 €	
26.1418	110 x 90	"	31,335 €	
Record com Rosca Fêmea				Artº 100
	26.1140	16 x 1/2"	Record rosca/fêmea	0,975 €
	26.1119	16 x 3/4"	"	0,975 €
	26.1116	20 x 1/2"	"	0,820 €
	26.1117	20 x 3/4"	"	0,820 €
	26.1141	25 x 1/2"	"	0,955 €
	26.1100	25 x 3/4"	"	0,955 €
	26.1101	25 x 1"	"	0,955 €
	26.1102	32 x 1/2"	"	1,600 €
	26.1103	32 x 3/4"	"	1,150 €
	26.1104	32 x 1"	"	1,150 €
	26.1105	40 x 1"	"	2,090 €
	26.1106	40 x 1.1/4"	"	2,090 €
	26.1107	40 x 1.1/2"	"	2,745 €
	26.1118	50 x 1.1/4"	"	2,715 €
	26.1108	50 x 1.1/2"	"	2,715 €
	26.1109	50 x 2"	"	3,895 €
	26.1111	63 x 1.1/2"	"	3,835 €
	26.1112	63 x 2"	"	3,835 €
	26.1113	63 x 2.1/2"	"	5,500 €
	26.1114	75 x 2"	"	8,135 €
26.1121	75 x 2.1/2"	"	8,135 €	
26.1120	90 x 2.1/2"	"	10,100 €	
26.1115	90 x 3"	"	10,100 €	

Nota: Esta tabela pode ser alterada sem aviso prévio, preços sujeitos à taxa de I.v.a. em vigor.
 Setúbal, 01 de Janeiro de 2018.



Hidrosado, Lda.
 Quinta Varzinha, Lote 25
 2900-721 Setúbal
 Telefone: 265537550
 Fax: 265537551
 Mail: geral@hidrosado.pt
 Site: www.hidrosado.pt

Acessórios de aperto rápido



	Código	Medida	Designação	Preço
Tês simples de plástico - 90°				Artº 80
	26.1008	16x16x16	Tês simples 90°	2,215 €
	26.1009	20x20x20	"	1,615 €
	26.1010	25x25x25	"	2,145 €
	26.1011	32x32x32	"	2,770 €
	26.1012	40x40x40	"	4,855 €
	26.1013	50x50x50	"	6,620 €
	26.1014	63x63x63	"	9,445 €
	26.1015	75x75x75	"	17,675 €
	26.1016	90x90x90	"	24,315 €
	26.1414	110x110x110	"	46,390 €
Tês redução de plástico - 90°				Artº 75
	26.1000	25x20x25	Tês redução 90°	2,335 €
	26.1001	32x25x32	"	2,700 €
	26.1002	40x32x40	"	4,340 €
	26.1003	50x40x50	"	5,955 €
	26.1004	63x50x63	"	7,780 €
	26.1005	75x63x75	"	14,775 €
	26.1006	90x75x90	"	24,315 €
	26.1438	110x90x110	"	46,390 €
Tês plástico rosca/mangueira				Artº 85
	26.1017	16 x 1/2" x 16	Tê de derivação	1,760 €
	26.1018	16 x 3/4" x 16	"	1,760 €
	26.1019	20 x 1/2" x 20	"	1,375 €
	26.1020	20 x 3/4" x 20	"	1,525 €
	26.1021	25 x 1/2" x 25	"	1,750 €
	26.1022	25 x 3/4" x 25	"	1,750 €
	26.1439	25 x 1" x 25	"	1,945 €
	26.1472	32 x 1/2" x 32	"	2,275 €
	26.1025	32 x 3/4" x 32	"	2,275 €
	26.1026	32 x 1" x 32	"	2,275 €
	26.1028	40 x 1" x 40	"	4,160 €
	26.1029	40 x 1.1/4" x 40	"	4,160 €
	26.1031	50 x 1.1/4" x 50	"	5,660 €
	26.1032	50 x 1.1/2" x 50	"	5,660 €
	26.1034	63 x 1.1/2" x 63	"	8,325 €
	26.1035	63 x 2" x 63	"	8,325 €
	26.1037	75 x 2" x 75	"	14,965 €
	26.1038	75 x 2.1/2" x 75	"	14,965 €
	26.1040	90 x 2.1/2" x 90	"	22,260 €
26.1041	90 x 3" x 90	"	22,260 €	
26.1467	110 x 3" x 110	"	33,670 €	
	26.1023	110 x 4" x 110	"	33,670 €



Nota: Esta tabela pode ser alterada sem aviso prévio, preços sujeitos à taxa de I.v.a. em vigor.
 Setúbal, 01 de Janeiro de 2018.



Hidrosado, Lda.
 Quinta Varzinha, Lote 25
 2900-721 Setúbal
 Telefone: 265537550
 Fax: 265537551
 Mail: geral@hidrosado.pt
 Site: www.hidrosado.pt

Acessórios de aperto rápido





Código	Medida	Designação	Preço	
Curvas rosca macho/mangueira			Artº 130	
	26,1426	16 x 1/2"	Curva plástico	1,110 €
	26,1054	16 x 3/4"	"	1,110 €
	26,1055	20 x 1/2"	"	0,830 €
	26,1490	20 x 3/4"	"	0,880 €
	26,1056	25 x 1/2"	"	1,065 €
	26,1476	25 x 3/4"	"	1,065 €
	26,1441	25 x 1"	"	1,065 €
	26,1057	32 x 1/2"	"	1,770 €
	26,1442	32 x 3/4"	"	1,375 €
	26,1212	32 x 1"	"	1,375 €
	26,1443	32 x 1.1/4"	"	1,890 €
	26,1444	40 x 1"	"	2,370 €
	26,1215	40 x 1.1/4"	"	2,370 €
	26,1445	40 x 1.1/2"	"	2,845 €
	26,1446	50 x 1.1/4"	"	2,995 €
	26,1218	50 x 1.1/2"	"	2,995 €
	26,1477	50 x 2"	"	3,905 €
	26,1478	63 x 1.1/2"	"	5,420 €
	26,1221	63 x 2"	"	4,160 €
	26,1479	63 x 2.1/2"	"	5,420 €
	26,1223	75 x 2.1/2"	"	9,355 €
	26,1058	75 x 3"	"	11,485 €
	26,1480	90 x 3"	"	11,750 €
	26,1481	90 x 4"	"	14,405 €
	26,1380	110 x 4"	"	22,915 €
Curvas rosca fêmea/mangueira			Artº 125	
	26,1059	16 x 1/2"	Curvas	1,125 €
	26,1060	16 x 3/4"	"	1,125 €
	26,1061	20 x 1/2"	"	0,980 €
	26,1491	20 x 3/4"	"	0,980 €
	26,1062	25 x 1/2"	"	1,165 €
	26,1482	25 x 3/4"	"	1,165 €
	26,1429	25 x 1"	"	1,165 €
	26,1063	32 x 1/2"	"	1,450 €
	26,1447	32 x 3/4"	"	1,450 €
	26,1430	32 x 1"	"	1,450 €
	26,1431	32 x 1.1/4"	"	2,750 €
	26,1448	40 x 1"	"	2,860 €
	26,1432	40 x 1.1/4"	"	2,860 €
	26,1449	40 x 1.1/2"	"	4,125 €
	26,1450	50 x 1.1/4"	"	3,600 €
	26,1433	50 x 1.1/2"	"	3,815 €
	26,1483	50 x 2"	"	5,495 €
	26,1451	63 x 1.1/2"	"	5,235 €
	26,1434	63 x 2"	"	5,235 €
	26,1484	63 x 2.1/2"	"	7,450 €
	26,1470	75 x 2.1/2"	"	10,000 €
	26,1485	75 x 3"	"	12,905 €
	26,1486	90 x 3"	"	18,425 €
	26,1064	90 x 4"	"	23,865 €
	26,1065	110 x 4"	"	29,930 €

Nota: Esta tabela pode ser alterada sem aviso prévio, preços sujeitos à taxa de I.v.a. em vigor.
 Setúbal, 01 de Janeiro de 2018.

Acessórios de aperto rápido

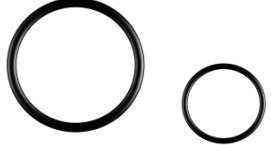

	Código	Medida	Designação	Preço
Tomadas em carga de plástico				Artº 140
	26.1261	25 x 1/2"	Tomadas em carga	1,480 €
	26.1262	25 x 3/4"	"	1,480 €
	26.1263	32 x 1/2"	"	1,700 €
	26.1264	32 x 3/4"	"	1,700 €
	26.1265	32 x 1"	"	2,120 €
	26.1266	40 x 1/2"	"	1,910 €
	26.1268	40 x 3/4"	"	1,910 €
	26.1269	40 x 1"	"	1,910 €
	26.1270	50 x 1/2"	"	2,120 €
	26.1271	50 x 3/4"	"	2,120 €
	26.1272	50 x 1"	"	2,120 €
	26.1273	50 x 1.1/4"	"	1,930 €
	26.1274	63 x 1/2"	"	3,180 €
	26.1275	63 x 3/4"	"	3,180 €
	26.1276	63 x 1"	"	3,180 €
	26.1277	63 x 1.1/4"	"	3,180 €
	26.1278	63 x 1.1/2"	"	5,270 €
	26.1279	75 x 1/2"	"	3,660 €
	26.1280	75 x 3/4"	"	3,660 €
		26.1282	75 x 1"	"
26.1283		75 x 1.1/4"	"	3,660 €
26.1284		75 x 1.1/2"	"	6,110 €
26.1285		75 x 2"	"	6,110 €
26.1286		90 x 1/2"	"	4,510 €
26.1287		90 x 3/4"	"	4,510 €
26.1288		90 x 1"	"	4,510 €
26.1289		90 x 1.1/4"	"	4,510 €
26.1290		90 x 1.1/2"	"	6,660 €
26.1291		90 x 2"	"	6,660 €
26,1488	110 x 2"	"	8,530 €	
Tomada em carga reforçada				
	26.1200	25 x 1/2"	T. em carga reforçada	2,320 €
	26.1201	25 x 3/4"	"	2,320 €
	26.1202	32 x 1/2"	"	2,510 €
	26.1203	32 x 3/4"	"	2,510 €
	26.1204	40 x 1/2"	"	3,070 €
	26.1205	40 x 3/4"	"	3,070 €
	26.1206	50 x 1/2"	"	3,820 €
	26.1207	50 x 3/4"	"	3,820 €
	26.1208	50 x 1"	"	3,930 €
	26.1209	63 x 1"	"	4,240 €
	26.1210	63 x 1.1/4"	"	4,240 €
Oringues de Borracha				Artº 921
	26,1044	20mm	Oringue	0,220 €
	26,1045	25mm	"	0,350 €
	26,1046	32mm	"	0,350 €
	26,1047	40mm	"	0,610 €
	26,1048	50mm	"	0,670 €
	26,1049	63mm	"	1,000 €
	26,1050	75mm	"	1,060 €
26,1051	90mm	"	1,485 €	

Nota: Esta tabela pode ser alterada sem aviso prévio, preços sujeitos à taxa de I.v.a. em vigor.

Setúbal, 01 de Janeiro de 2018.

Acessórios de aperto rápido



Código	Medida (Ø)	Designação	Preço
Tês plástico rosca macho/mangueira			artº 8090
26,1180	20 x ½" x 20	Tês rosca macho/mangueira	1,450 €
26,1183	25 x ¾" x 25	"	1,885 €
26,1186	32 x 1" x 32	"	2,375 €
26,1188	40 x 1.¼" x 40	"	4,155 €
26,1191	50 x 1.½" x 50	"	5,895 €
26,1193	63 x 2" x 63	"	11,505 €
26,1194	75 x 2.½" x 75	"	15,055 €
26,1195	90 x 3" x 90	"	21,795 €



Pater			Artº 8127
26,1229	20 x ½"	Pater para muro	2,305 €
26,1230	25 x ¾"		2,755 €



Curva com derivação			Artº 8128
26,1197	25 x ½" x 25	Curva com derivação	1,840 €
26,1198	32 x ¾" x 32		2,755 €



Chaves para aperto			Artº 198
26.1471	20 - 32	Chave Pequena	1,970 €
26.1404	40 - 63	"	3,220 €
26.1405	63 - 110	Chave Grande	10,220 €



Acessórios de transição universal

26.1235	1" x 15-21	Record macho universal	4,14 €
26.1236	1.¼" x 21-27	"	5,40 €
26.1237	1.½" x 27-35	"	6,75 €



Válvulas esfera plásticas - SAB - F/F

26.1970	¾"	"	2,66 €
26.1971	1"	"	2,98 €
26.1972	1.¼"	"	6,22 €
26.1973	1.½"	"	10,22 €
26.1974	2"	"	14,44 €



Válvulas esfera plásticas - SAB - M/F

26.1975	¾"	"	2,66 €
26.1976	1"	"	2,98 €
26.1977	1.¼"	"	6,22 €
26.1978	1.½"	"	10,22 €
26.1979	2"	"	14,44 €





Hidrosado, Lda.
 Quinta Varzinha, Lote 25
 2900-721 Setúbal
 Telefone: 265537550
 Fax: 265537551
 Mail: geral@hidrosado.pt
 Site: www.hidrosado.pt

Acessórios de aperto rápido



Código	Medida (Ø)	Designação	Preço
União para Manga LAYFIT			
26,1352	1. ½"	União Layfit	16,00 €
26,1353	2"	"	19,30 €
26,1354	2. ½"	"	28,00 €
26,1355	3"	"	33,50 €
26,1356	4"	"	60,40 €
Record LAYFIT			
26,1393	1. ½" x 1. ¼"	Record Layfit	8,60 €
26,1394	1. ½" x 1. ½"	"	8,60 €
26,1395	1. ½" x 2"	"	8,60 €
26,1396	2" x 1. ½"	"	10,80 €
26,1397	2" x 2"	"	10,80 €
União redução LAYFIT			
26,1325	2" x 1. ½"	União redução Layfit	18,40 €
26,1326	2. ½" x 2"	"	26,50 €
26,1327	3" x 2. ½"	"	32,60 €
Curva Macho LAYFIT			
26,1328	1. ½" x 1. ¼"	Curva Macho Layfit	9,10 €
26,1329	1. ½" x 1. ½"	"	9,10 €
26,1330	2" x 1. ½"	"	11,20 €
26,1331	2" x 2"	"	11,20 €
Curva Fêmea LAYFIT			
26,1332	1. ½" x 1. ¼"	Curva fêmea Layfit	12,30 €
26,1333	1. ½" x 1. ½"	"	12,30 €
26,1334	2" x 1. ½"	"	14,10 €
26,1335	2" x 2"	"	14,10 €
Tampão LAYFIT			
26,1336	1. ½"	Tampão Layfit	9,70 €
26,1337	2"	"	11,70 €
26,1338	2. ½"	"	20,40 €
26,1339	3"	"	23,40 €
26,1340	4"	"	44,50 €
Tê LAYFIT			
26,1341	1. ½"	Tê Layfit	24,30 €
26,1342	2"	"	29,70 €
26,1343	2. ½"	"	36,90 €
26,1344	3"	"	46,50 €
26,1345	4"	"	80,00 €
Unões rápidas Plug & Play			
26,1398	90 x 90	União Plug & Play	23,62 €
26,1399	110 x 110	"	32,16 €

Nota: Esta tabela pode ser alterada sem aviso prévio, preços sujeitos à taxa de I.v.a. em vigor.
 Setúbal, 01 de Janeiro de 2018.



Hidrosado, Lda.

Quinta Varzinha, Lote 25

2900-721 Setúbal

Telefone: 265537550

Fax: 265537551

Mail: geral@hidrosado.pt

Site: www.hidrosado.pt

Válvulas PVC diversas

plimat
EXCELLENT IN PIPE FITTINGS

Código	Ø	Preço
--------	---	-------

Valvulas esfera Roscar



26.1381	¾"	7,13 €
26.1456	1"	7,88 €
26.1457	1.¼"	10,79 €
26.1458	1.½"	11,62 €
26.1459	2"	17,09 €
26.1460	2.½"	65,29 €
26.1492	3"	76,49 €

Código	Ø	Preço
--------	---	-------

Valvulas esfera Colar



26.1382	25mm	6,65 €
26.1461	32mm	7,04 €
26.1462	40mm	9,96 €
26.1463	50mm	10,63 €
26.1464	63mm	15,77 €
26.1465	75mm	61,90 €
26.1493	90mm	72,50 €

Código	Ø	Preço
--------	---	-------

Válvulas esfera aperto rápido M/F



26.1750	½" x 16	4,94 €
26.1751	½" x 20	4,94 €
26.1752	¾" x 25	6,06 €
26.1753	1" x 32	7,35 €
26.1754	1.¼" x 40	10,37 €
26.1755	1.½" x 50	12,13 €
26.1756	2" x 63	16,87 €

Código	Ø	Preço
--------	---	-------

Válvulas esfera aperto rápido



26.1494	20mm	6,23 €
26.1495	25mm	8,29 €
26.1496	32mm	11,20 €
26.1497	40mm	13,28 €
26.1498	50mm	16,60 €
26.1499	63mm	21,99 €
26.1437	75mm	111,73 €
26.1489	90mm	135,57 €

Código	Ø	Preço
--------	---	-------

Valvulas retenção Roscar



26.1710	½"	6,86 €
26.1711	¾"	8,94 €
26.1712	1"	9,90 €
26.1713	1.¼"	13,57 €
26.1714	1.½"	14,53 €
26.1715	2"	21,39 €

Código	Ø	Preço
--------	---	-------

Valvulas retenção Colar



26.1716	20mm	6,23 €
26.1717	25mm	8,29 €
26.1718	32mm	8,78 €
26.1719	40mm	12,45 €
26.1720	50mm	13,25 €
26.1721	63mm	19,62 €

Código	Ø	Preço
--------	---	-------

Válvulas retenção aperto rápido



26.1722	20mm	7,82 €
26.1723	25mm	10,37 €
26.1724	32mm	14,03 €
26.1725	40mm	16,60 €
26.1726	50mm	20,74 €
26.1727	63mm	27,45 €

Código	Ø	Preço
--------	---	-------

Válvulas Borboleta



26.1770	75mm	78,74 €
26.1771	90mm	86,17 €
26.1772	110mm	95,81 €
26.1773	140/125mm	111,43 €
26.1774	160mm	135,93 €
26.1775	200/225mm	216,91 €

Código	Ø	Preço
--------	---	-------

Valvulas retenção c/Janela Colar



26.1708	50mm	15,79 €
26.1709	63mm	20,26 €

Nota: Esta tabela pode ser alterada sem aviso prévio, preços sujeitos à taxa de I.v.a. em vigor.

Setúbal, 01 de Janeiro de 2018.

Pág.: 80



Hidrosado, Lda.
 Quinta Varzinha, Lote 25
 2900-721 Setúbal
 Telefone: 265537550
 Fax: 265537551
 Mail: geral@hidrosado.pt
 Site: www.hidrosado.pt

Acessórios P.V.C.

ROSCAR

plimat

EXCELLENT IN PIPE FITTINGS



Código	Medida	Preço
JOELHOS P.V.C 90°		
26,1500	½ "	0,61 €
26,1501	¾ "	0,91 €
26,1502	1"	1,26 €
26,1503	1.¼"	1,96 €
26,1504	1.½ "	2,60 €
26,1505	2"	3,70 €
26,1571	2.½"	11,88 €
26,1572	3"	18,20 €



Código	Medida	Preço
TAMPÕES M. P.V.C.		
26,1535	½ "	0,36 €
26,1536	¾ "	0,51 €
26,1537	1"	0,65 €
26,1538	1.¼"	0,90 €
26,1539	1.½ "	1,23 €
26,1540	2"	1,77 €
26,1595	2.½"	3,57 €
26,1596	3"	5,72 €



Código	Medida	Preço
TÊS P.V.C. 90°		
26,1507	½ "	0,93 €
26,1508	¾ "	1,22 €
26,1509	1"	1,63 €
26,1510	1.¼"	2,63 €
26,1511	1.½ "	3,35 €
26,1512	2"	5,25 €
26,1575	2.½"	15,23 €
26,1576	3"	20,41 €



Código	Medida	Preço
JUNÇÕES P.V.C. F/F		
26,1543	½ "	1,97 €
26,1544	¾ "	2,48 €
26,1545	1"	3,07 €
26,1546	1.¼"	4,20 €
26,1547	1.½ "	6,05 €
26,1548	2"	8,33 €



Código	Medida	Preço
UNIÕES SIMPLES P.V.C.		
26,1515	½ "	0,52 €
26,1516	¾ "	0,60 €
26,1517	1"	0,83 €
26,1518	1.¼"	1,17 €
26,1519	1.½ "	1,67 €
26,1520	2"	2,98 €
26,1580	2.½"	7,62 €
26,1581	3"	9,28 €



Código	Medida	Preço
JUNÇÕES P.V.C. M/F		
26,1930	½ "	2,06 €
26,1931	¾ "	2,60 €
26,1932	1"	3,23 €
26,1933	1.¼"	4,40 €
26,1934	1.½ "	6,35 €
26,1935	2"	8,75 €



Código	Medida	Preço
CASQUILHOS DUPLOS		
26,1523	½ "	0,55 €
26,1524	¾ "	0,67 €
26,1525	1"	0,90 €
26,1526	1.¼"	1,32 €
26,1527	1.½ "	1,81 €
26,1528	2"	2,80 €
26,1585	2.½"	3,48 €
26,1586	3"	5,18 €



Código	Medida	Preço
UNIÕES DE RED.M/F P.V.C.		
26,1551	¾ " x ½ "	0,83 €
26,1553	1" x ½ "	1,03 €
26,1554	1" x ¾ "	1,03 €
26,1555	1.¼" x ½ "	1,65 €
26,1556	1.¼" x ¾ "	1,65 €
26,1557	1.¼" x 1"	1,65 €
26,1558	1.½" x ½ "	1,92 €
26,1559	1.½" x ¾ "	1,92 €
26,1560	1.½" x 1"	1,92 €
26,1561	1.½" x 1.¼"	1,92 €
26,1562	2" x ¾ "	2,88 €
26,1563	2" x 1"	2,88 €
26,1564	2" x 1.¼"	2,88 €
26,1565	2" x 1.½"	2,88 €



Código	Medida	Preço
TAMPÕES F. P.V.C.		
26,1529	½ "	0,48 €
26,1530	¾ "	0,60 €
26,1531	1"	0,77 €
26,1532	1.¼"	1,27 €
26,1533	1.½ "	1,57 €
26,1534	2"	2,13 €
26,1590	2.½"	5,95 €
26,1591	3"	10,00 €



Código	Medida	Preço
JOELHOS RED. 90°		
26,1567	¾ " x ½ "	0,93 €



Código	Medida	Preço
TÊS REDUÇÃO. 90°		
26,1568	¾ " x ½ "	1,23 €

Nota: Esta tabela pode ser alterada sem aviso prévio, preços sujeitos à taxa de I.v.a. em vigor.
 Setúbal, 01 de Janeiro de 2018.



Hidrosado, Lda.

Quinta Varzinha, Lote 25

2900-721 Setúbal

Telefone: 265537550

Fax: 265537551

Mail: geral@hidrosado.pt

Site: www.hidrosado.pt

Acessórios P.V.C.

COLAR

plimat
EXCELLENT IN PIPE FITTINGS



Código	Medida	Preço
JOELHOS P.V.C 90°		
26,1600	20mm	0,32 €
26,1601	25mm	0,40 €
26,1602	32mm	0,65 €
26,1603	40mm	0,98 €
26,1604	50mm	1,37 €
26,1605	63mm	2,15 €
26,1606	75mm	3,87 €
26,1607	90mm	6,40 €
26,1608	110mm	11,13 €
26,1609	125mm	18,00 €
26,1685	140mm	31,88 €
26,1686	160mm	34,70 €



Código	Medida	Preço
JOELHOS COLAR 45°		
26,1645	20mm	0,43 €
26,1646	25mm	0,48 €
26,1647	32mm	0,72 €
26,1648	40mm	0,90 €
26,1649	50mm	1,20 €
26,1650	63mm	2,07 €
26,1651	75mm	3,52 €
26,1652	90mm	5,73 €
26,1653	110mm	11,13 €
26,1687	125mm	16,87 €
26,1688	140mm	28,13 €
26,1689	160mm	33,75 €



Código	Medida	Preço
UNIÕES SIMPLES P.V.C.		
26,1612	20mm	0,35 €
26,1613	25mm	0,42 €
26,1614	32mm	0,48 €
26,1615	40mm	0,75 €
26,1616	50mm	1,00 €
26,1617	63mm	1,62 €
26,1618	75mm	3,32 €
26,1619	90mm	3,53 €
26,1620	110mm	6,85 €
26,1701	125mm	10,53 €
26,1702	140mm	17,48 €
26,1703	160mm	19,10 €



Código	Medida	Preço
TAMPÕES FEMEAS		
26,1654	20mm	0,32 €
26,1655	25mm	0,33 €
26,1656	32mm	0,47 €
26,1657	40mm	0,90 €
26,1658	50mm	1,12 €
26,1659	63mm	1,32 €
26,1660	75mm	3,03 €
26,1661	90mm	3,75 €
26,1662	110mm	8,43 €



Código	Medida	Preço
JUNÇÕES SIMPLES P.V.C.		
26,1621	20mm	1,55 €
26,1622	25mm	1,90 €
26,1623	32mm	2,22 €
26,1624	40mm	2,73 €
26,1625	50mm	4,03 €
26,1626	63mm	5,18 €



Código	Medida	Preço
TÊS REDUÇÃO 90°		
26,1610	25x20	0,48 €
26,1611	32x20	0,92 €
26,1690	32x25	0,92 €
26,1639	40x20	1,85 €
26,1642	40x25	1,85 €
26,1691	40x32	1,85 €
26,1643	50x20	1,92 €
26,1644	50x25	1,92 €
26,1683	50x32	1,92 €
26,1692	50x40	1,92 €
26,1664	63x50	2,70 €
26,1665	75x50	5,15 €
26,1666	75x63	5,15 €
26,1667	90x50	8,40 €
26,1668	90x63	8,40 €
26,1669	90x75	8,40 €
26,1670	110x50	14,53 €
26,1671	110x63	14,53 €
26,1672	110x75	14,53 €
26,1673	110x90	14,53 €



Código	Medida	Preço
TÊS COLAR 90°		
26,1627	20mm	0,40 €
26,1628	25mm	0,48 €
26,1629	32mm	0,75 €
26,1630	40mm	1,30 €
26,1631	50mm	1,88 €
26,1632	63mm	2,70 €
26,1633	75mm	5,15 €
26,1634	90mm	8,40 €
26,1635	110mm	14,53 €
26,1636	125mm	25,17 €
26,1705	140mm	41,40 €
26,1706	160mm	43,77 €



Código	Medida	Preço
CRUZETAS DE COLAR		
26,1699	20mm	2,01 €
26,1695	25mm	2,37 €
26,1696	32mm	2,65 €
26,1697	40mm	3,60 €
26,1637	50mm	4,68 €
26,1638	63mm	8,13 €
26,1641	75mm	12,01 €
26,1640	90mm	15,93 €

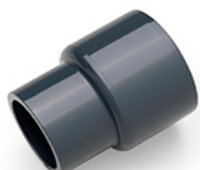

Código	Medida	Preço
UNIÕES DE REDUÇÃO		
26,1698	32x25	0,48 €
26,1693	40x32	0,58 €
26,1694	50x40	1,47 €
26,1674	63x50	1,52 €
26,1675	75x50	3,03 €
26,1676	75x63	3,03 €
26,1677	90x50	5,63 €
26,1678	90x63	5,63 €
26,1679	90x75	5,63 €
26,1680	110x63	8,15 €
26,1681	110x75	8,15 €
26,1682	110x90	8,15 €

Nota: Esta tabela pode ser alterada sem aviso prévio, preços sujeitos à taxa de I.v.a. em vigor.

Setúbal, 01 de Janeiro de 2018.

Pág.: 82



Hidrosado, Lda.
 Quinta Varzinha, Lote 25
 2900-721 Setúbal
 Telephone: 265537550
 Fax: 265537551
 Mail: geral@hidrosado.pt
 Site: www.hidrosado.pt

Acessórios P.V.C.

TRANSIÇÃO

plimat
 EXCELLENT IN PIPE FITTINGS



Código	Medida	Preço
TÊS 90°		
26,1790	20 x 1/2"	0,82 €
26,1791	25 x 1/2"	0,95 €
26,1792	25 x 3/4"	0,95 €
26,1793	32 x 1"	1,17 €
26,1794	40 x 1.1/4"	1,97 €
26,1795	50 x 1.1/2"	2,85 €
26,1797	63 x 1.1/2"	3,55 €
26,1798	63 x 2"	3,55 €
26,1799	75 x 1.1/2"	5,98 €
26,1800	75 x 2.1/2"	13,00 €
26,1801	90 x 1.1/2"	9,30 €
26,1870	90 x 3"	19,32 €
26,1802	110 x 1.1/2"	14,67 €
26,1803	110 x 2"	14,67 €
26,1871	110 x 4"	31,57 €



Código	Medida	Preço
UNIÕES MACHO/FEMEA		
26,1814	20 x 1/2"	0,42 €
26,1816	25 x 3/4"	0,43 €
26,1817	32 x 1"	0,50 €
26,1818	40 x 1.1/4"	0,93 €
26,1885	50 x 1"	1,15 €
26,1819	50 x 1.1/2"	0,97 €
26,1820	63 x 1"	1,65 €
26,1822	63 x 1.1/2"	1,65 €
26,1823	63 x 2"	1,75 €



Código	Medida	Preço
UNIÕES FEMEA/FEMEA		
26,1828	20 x 1/2"	0,58 €
26,1830	25 x 3/4"	0,75 €
26,1831	32 x 1"	0,77 €
26,1832	40 x 1.1/4"	0,87 €
26,1833	50 x 1.1/2"	1,52 €
26,1837	63 x 2"	2,15 €
26,1886	75 x 2.1/2"	5,57 €
26,1834	90 x 3"	7,80 €
26,1836	110 x 4"	12,25 €



Código	Medida	Preço
JOELHOS 90°		
26,1804	20 x 1/2"	0,72 €
26,1805	25 x 1/2"	0,82 €
26,1806	25 x 3/4"	0,78 €
26,1807	32 x 1"	1,01 €
26,1808	40 x 1.1/4"	1,75 €
26,1810	50 x 1.1/2"	2,38 €
26,1811	63 x 2"	2,90 €
26,1872	75 x 2.1/2"	11,13 €
26,1873	90 x 3"	17,45 €
26,1874	110 x 4"	26,73 €



Código	Medida	Preço
JUNÇÕES F		
26,1856	20 x 1/2"	1,60 €
26,1858	25 x 3/4"	1,90 €
26,1859	32 x 1"	2,28 €
26,1860	40 x 1.1/4"	2,78 €
26,1862	50 x 1.1/2"	4,23 €
26,1865	63 x 2"	6,03 €



Código	Medida	Preço
UNIÕES MULT. F/M/M		
26,1841	20x25x1/2"	0,48 €
26,1890	20x25x3/4"	0,48 €
26,1891	25x32x1/2"	0,52 €
26,1842	25x32x3/4"	0,52 €
26,1892	25x32x1"	0,52 €
26,1897	32x40x3/4"	0,63 €
26,1843	32x40x1"	0,63 €
26,1893	32x40x1.1/4"	0,78 €
26,1894	40x50x1"	0,90 €
26,1844	40x50x1.1/4"	0,90 €
26,1845	40x50x1.1/2"	1,08 €
26,1895	50x63x1"	1,65 €
26,1896	50x63x1.1/4"	1,65 €
26,1846	50x63x1.1/2"	1,65 €
26,1847	50x63x2"	1,65 €
26,1848	75x90x2.1/2"	4,45 €
26,1849	75x90x3"	4,45 €
26,1850	90x110x2.1/2"	5,88 €
26,1851	90x110x3"	5,88 €
26,1852	90x110x4"	7,42 €
26,1853	110x125x2.1/2"	6,78 €
26,1854	110x125x3"	8,43 €
26,1855	110x125x4"	8,43 €



Código	Medida	Preço
Junções F/M		
26,1875	20 x 1/2"	1,68 €
26,1876	25 x 3/4"	1,98 €
26,1877	32 x 1"	2,40 €
26,1878	40 x 1.1/4"	2,93 €
26,1879	50 x 1.1/2"	4,43 €
26,1880	63 x 2"	6,05 €

Nota: Esta tabela pode ser alterada sem aviso prévio, preços sujeitos à taxa de I.v.a. em vigor.
 Setúbal, 01 de Janeiro de 2018.



Hidrosado, Lda.

Quinta Varzinha, Lote 25

2900-721 Setúbal

Telefone: 265537550

Fax: 265537551

Mail: geral@hidrosado.pt

Site: www.hidrosado.pt

Acessórios P.V.C.

TRANSIÇÃO / COLAR / PISCINA

plimat
EXCELLENT IN PIPE FITTINGS

Código	Medida mm / Ø	Preço
--------	------------------	-------

Redução curta

26.1900	20x16	0,30 €
26.1901	25x16	0,31 €
26.1902	25x20	0,31 €
26.1903	32x20	0,33 €
26.1904	32x25	0,33 €
26.1905	40x25	0,50 €
26.1906	40x32	0,50 €
26.1907	50x20	0,50 €
26.1908	50x25	0,50 €
26.1909	50x32	0,50 €
26.1910	50x40	0,50 €
26.1911	63x40	0,87 €
26.1912	63x50	0,87 €
26.1913	75x50	1,43 €
26.1914	75x63	1,43 €
26.1915	90x63	2,45 €
26.1916	90x75	2,45 €
26.1917	110x50	4,62 €
26.1918	110x63	4,62 €
26.1919	110x75	4,62 €
26.1920	110x90	4,62 €

Colarinhos

26.1921	50mm	1,42 €
26.1922	63mm	1,80 €
26.1923	75mm	2,15 €
26.1924	90mm	3,32 €
26.1925	110mm	5,27 €
26.1926	125mm	6,85 €
26.1927	140mm	9,57 €
26.1928	160mm	12,75 €
26.1929	200mm	23,50 €

Flanges livres

26.1960	50mm	2,82 €
26.1961	63mm	3,08 €
26.1962	75mm	3,53 €
26.1963	90mm	4,23 €
26.1964	110mm	7,90 €
26.1965	125mm	10,63 €
26.1966	140mm	13,13 €
26.1967	160mm	14,05 €
26.1968	200mm	20,28 €

Código	Medida mm / Ø	Preço
--------	------------------	-------

Colarinhos estriados

26.1950	50mm	1,68 €
26.1951	63mm	2,20 €
26.1952	75mm	2,58 €
26.1953	90mm	4,00 €
26.1954	110mm	6,85 €
26.1955	125mm	9,57 €
26.1956	140mm	13,25 €
26.1957	160mm	14,82 €
26.1958	200mm	27,03 €

Junções p/Piscina F/F

01.10.1278.007/010

26.1980	32 x 1"	2,02 €
26.1981	40 x 1.¼"	3,03 €
26.1942	50 x 1.½"	3,93 €
26.1943	63 x 2"	5,88 €

Junções p/Piscina F/M

01.10.1279.007/10

26.1984	32 x 1"	2,13 €
26.1985	40 x 1.¼"	3,13 €
26.1944	50 x 1.½"	3,53 €
26.1986	50 x 2"	4,82 €
26.1945	63 x 2"	5,38 €

Junções p/Piscina F/M/F

01.10.1323.009/19

26.1988	25 x 32 x 1"	2,13 €
26.1989	32 x 40 x 1.¼"	3,28 €
26.1990	40 x 50 x 1.½"	3,83 €
26.1991	50 x 63 x 2"	5,62 €

Junções F/M/M

01.10.1324.009/19

26.1992	25 x 32 x 1"	2,23 €
26.1993	32 x 40 x 1.¼"	3,40 €
26.1994	40 x 50 x 1.½"	3,75 €
26.1995	50 x 63 x 2"	5,35 €



Nota: Esta tabela pode ser alterada sem aviso prévio, preços sujeitos à taxa de I.v.a. em vigor.

Setúbal, 01 de Janeiro de 2018.

Pág.: 84

Acessórios P.P.R.

Tubos PPR

Codigo	Med. Ext.	Ø - 4 mts	Côr	Preço/mt
29,1000	20 x 3,4	½"	verm.	1,31 €
29,1001	25 x 4,2	¾"	verm.	1,89 €
29,1002	32 x 5,4	1"	verm.	3,15 €
29,1003	40 x 6,7	1.¼"	verm.	4,49 €
29,1004	50 x 8,4	1.½"	verm.	7,37 €
29,1006	20 x 3,4	½"	azul	1,18 €
29,1007	25 x 4,2	¾"	azul	1,84 €
29,1008	32 x 5,4	1"	azul	3,03 €
29,1360	40 x 6,7	1.¼"	azul	3,70 €

Uniões de cruzamento

Codigo	Med. Ext.	Ø	Côr	Preço
29,1010	20	½"	verm.	1,19 €
29,1011	25	¾"	verm.	1,39 €
29,1012	32	1"	verm.	4,06 €
29,1013	20	½"	azul	1,12 €
29,1014	25	¾"	azul	1,46 €
29,1015	32	1"	azul	2,34 €

Uniões simples

Codigo	Med. Ext.	Ø	Côr	Preço
29,1020	20	½"	verm.	0,16 €
29,1021	25	¾"	verm.	0,26 €
29,1022	32	1"	verm.	0,43 €
29,1023	40	1.¼"	verm.	0,71 €
29,1024	50	1.½"	verm.	1,19 €
29,1026	20	½"	azul	0,20 €
29,1027	25	¾"	azul	0,26 €
29,1028	32	1"	azul	0,40 €
29,1363	40	1.¼"	azul	0,67 €

Junção simples

Codigo	Med. Ext.	Ø	Côr	Preço
29,1030	20	½"	verm.	0,95 €
29,1031	25	¾"	verm.	1,49 €
29,1032	32	1"	verm.	2,39 €
29,1033	40	1.¼"	verm.	3,99 €
29,1034	20	½"	azul	0,90 €
29,1035	25	¾"	azul	1,36 €
29,1036	32	1"	azul	1,99 €

Uniões redução

Codigo	Med. Ext.	Ø	Côr	Preço
29,1040	25 x 20	¾" x ½"	verm.	0,25 €
29,1041	32 x 20	1" x ½"	verm.	0,35 €
29,1042	32 x 25	1" x ¾"	verm.	0,38 €
29,1043	40 x 20	1.¼" x ½"	verm.	0,53 €
29,1044	40 x 25	1.¼" x ¾"	verm.	0,56 €
29,1045	40 x 32	1.¼" x 1"	verm.	0,60 €
29,1046	50 x 20	1.½" x ½"	verm.	0,89 €
29,1047	50 x 25	1.½" x ¾"	verm.	0,90 €
29,1048	50 x 32	1.½" x 1"	verm.	0,98 €
29,1049	25 x 20	¾" x ½"	azul	0,26 €
29,1050	32 x 20	1" x ½"	azul	0,34 €
29,1051	32 x 25	1" x ¾"	azul	0,40 €

Uniões roscada fêmea

Codigo	Med. Ext.	Ø	Côr	Preço
29,1060	20 x ½"	½" x ½"	verm.	2,25 €
29,1061	20 x ¾"	½" x ¾"	verm.	2,86 €
29,1062	25 x ½"	¾" x ½"	verm.	2,29 €
29,1063	25 x ¾"	¾" x ¾"	verm.	2,95 €
29,1064	32 x ¾"	1" x ¾"	verm.	3,16 €
29,1065	32 x 1"	1" x 1"	verm.	6,40 €
29,1066	40 x 1.¼"	1.¼" x 1.¼"	verm.	11,18 €
29,1067	50 x 1.½"	1.½" x 1.½"	verm.	14,40 €
29,1068	20 x ½"	½" x ½"	azul	1,92 €
29,1069	25 x ½"	¾" x ½"	azul	2,01 €
29,1070	25 x ¾"	¾" x ¾"	azul	2,90 €
29,1072	32 x ¾"	1" x ¾"	azul	3,27 €
29,1071	32 x 1"	1" x 1"	azul	5,70 €

União roscada macho

Codigo	Med. Ext.	Ø	Côr	Preço
29,1080	20 x ½"	½" x ½"	verm.	2,58 €
29,1081	20 x ¾"	½" x ¾"	verm.	3,28 €
29,1082	25 x ½"	¾" x ½"	verm.	2,76 €
29,1083	25 x ¾"	¾" x ¾"	verm.	3,48 €
29,1084	32 x ¾"	1" x ¾"	verm.	3,50 €
29,1085	32 x 1"	1" x 1"	verm.	7,65 €
29,1086	40 x 1.¼"	1.¼" x 1.¼"	verm.	11,79 €
29,1088	20 x ½"	½" x ½"	azul	2,01 €
29,1089	25 x ½"	¾" x ½"	azul	2,24 €
29,1090	25 x ¾"	¾" x ¾"	azul	3,26 €
29,1092	32 x ¾"	1" x ¾"	azul	3,69 €
29,1091	32 x 1"	1" x 1"	azul	7,18 €
29,1364	40 x 1.¼"	1.¼" x 1.¼"	azul	11,83 €

Acessórios P.P.R.

Tê roscado macho

Código	Med. Ext.	Ø	Côr	Preço
29,1175	20 x 1/2"x20	1/2"x1/2"x1/2"	verm.	2,98 €
29,1176	25x1/2"x25	3/4"x1/2"x3/4"	verm.	3,36 €
29,1177	25x3/4"x25	3/4"x3/4"x3/4"	verm.	4,19 €
29,1178	32x1/2"x32	1"x1/2"x1"	verm.	3,67 €
29,1179	32x3/4"x32	1"x3/4"x1"	verm.	4,53 €
29,1180	32x1"x32	1"x1"x1"	verm.	8,26 €
29,1181	20 x 1/2"x20	1/2"x1/2"x1/2"	azul	2,48 €
29,1182	25x1/2"x25	3/4"x1/2"x3/4"	azul	2,58 €
29,1183	25x3/4"x25	3/4"x3/4"x3/4"	azul	2,80 €
29,1184	32x1"x32	1"x1"x1"	azul	8,41 €

Joelho 90°

Código	Med. Ext.	Ø	Côr	Preço
29,1185	20	1/2"	verm.	0,26 €
29,1186	25	3/4"	verm.	0,45 €
29,1187	32	1"	verm.	0,70 €
29,1188	40	1.1/4"	verm.	1,30 €
29,1189	50	1.1/2"	verm.	2,31 €
29,1190	63	2"	verm.	4,08 €
29,1191	20	1/2"	azul	0,26 €
29,1192	25	3/4"	azul	0,34 €
29,1193	32	1"	azul	0,57 €

Joelho 45°

Código	Med. Ext.	Ø	Côr	Preço
29,1195	20	1/2"	verm.	0,26 €
29,1196	25	3/4"	verm.	0,41 €
29,1197	32	1"	verm.	0,69 €
29,1198	40	1.1/4"	verm.	1,10 €
29,1199	50	1.1/2"	verm.	1,86 €
29,1200	63	2"	verm.	3,64 €
29,1201	20	1/2"	azul	0,26 €
29,1202	25	3/4"	azul	0,34 €
29,1203	32	1"	azul	0,72 €

Joelho redução 90°

Código	Med. Ext.	Ø	Côr	Preço
29,1205	25 x 20	3/4" x 1/2"	verm.	0,49 €
29,1206	32 x 20	1" x 1/2"	verm.	0,68 €
29,1207	32 x 25	1" x 3/4"	verm.	0,83 €
29,1208	25 x 20	3/4" x 1/2"	azul	0,44 €
29,1209	32 x 20	1" x 1/2"	azul	0,60 €
29,1210	32 x 25	1" x 3/4"	azul	0,76 €

Joelho m/f 90°

Código	Med. Ext.	Ø	Côr	Preço
29,1215	20	1/2"	verm.	0,36 €
29,1216	25	3/4"	verm.	0,55 €

Joelho roscado fêmea

Código	Med. Ext.	Ø	Côr	Preço
29,1220	20 x 1/2"	1/2" x 1/2"	verm.	2,46 €
29,1221	25 x 1/2"	3/4" x 1/2"	verm.	2,86 €
29,1222	25 x 3/4"	3/4" x 3/4"	verm.	3,46 €
29,1223	32 x 1/2"	1" x 1/2"	verm.	3,50 €
29,1224	32x3/4"	1" x 3/4"	verm.	3,96 €
29,1225	32x1"	1"x1"	verm.	7,40 €
29,1226	40x1"	1.1/4"x1"	verm.	8,76 €
29,1227	20 x 1/2"	1/2" x 1/2"	azul	1,92 €
29,1228	25 x 1/2"	3/4" x 1/2"	azul	2,14 €
29,1229	25 x 3/4"	3/4" x 3/4"	azul	3,36 €
29,1230	32 x 1"	1" x 1/2"	azul	6,92 €

Joelho roscado macho

Código	Med. Ext.	Ø	Côr	Preço
29,1231	20 x 1/2"	1/2" x 1/2"	verm.	2,80 €
29,1232	25 x 1/2"	3/4" x 1/2"	verm.	3,30 €
29,1233	25 x 3/4"	3/4" x 3/4"	verm.	3,80 €
29,1234	32 x 1/2"	1" x 1/2"	verm.	3,60 €
29,1235	32 x 3/4"	1" x 3/4"	verm.	4,20 €
29,1236	32 x 1"	1"x1"	verm.	7,99 €
29,1237	20 x 1/2"	1/2" x 1/2"	azul	2,58 €
29,1238	25 x 1/2"	3/4" x 1/2"	azul	3,03 €
29,1239	25 x 3/4"	3/4" x 3/4"	azul	3,46 €
29,1240	32 x 1"	1"x1"	azul	7,94 €

Joelho macho roscado fêmea

Código	Med. Ext.	Ø	Côr	Preço
29,1241	20 x 1/2"	1/2" x 1/2"	verm.	4,75 €

Joelho c/junção 90°

Código	Med. Ext.	Ø	Côr	Preço
29,1242	20 x 3/4"	1/2" x 3/4"	verm.	6,43 €
29,1243	25 x 3/4"	3/4" x 3/4"	verm.	6,58 €
29,1244	25 x 1"	3/4" x 1"	verm.	7,89 €
29,1245	32 x 1.1/4"	1" x 1.1/4"	verm.	13,81 €
29,1246	20 x 3/4"	1/2" x 3/4"	azul	5,86 €
29,1247	25 x 3/4"	3/4" x 3/4"	azul	5,99 €
29,1248	25 x 1"	3/4" x 1"	azul	7,18 €
29,1249	32 x 1.1/4"	1" x 1.1/4"	azul	12,62 €



Hidrosado, Lda.

Quinta Varzinha, Lote 25

2900-721 Setúbal

Telefone: 265537550

Fax: 265537551

Mail: geral@hidrosado.pt

Site: www.hidrosado.pt

Acessórios P.P.R.

União roscada fêmea com junção

Codigo	Med. Ext.	Ø	Côr	Preço
29,1100	20 x 3/4"	1/2" x 3/4"	verm.	6,16 €
29,1101	25 x 3/4"	3/4" x 3/4"	verm.	6,24 €
29,1102	25 x 1"	3/4" x 1"	verm.	5,96 €
29,1103	32 x 1"	1" x 1"	verm.	6,10 €
29,1104	32 x 1.1/4"	1" x 1.1/4"	verm.	13,26 €
29,1105	40 x 1.1/2"	1.1/4" x 1.1/2"	verm.	27,40 €
29,1106	20 x 3/4"	1/2" x 3/4"	azul	5,60 €
29,1107	25 x 3/4"	3/4" x 3/4"	azul	5,68 €
29,1108	25 x 1"	3/4" x 1"	azul	5,42 €
29,1109	32 x 1.1/4"	1" x 1.1/4"	azul	12,08 €



Junção soldar roscar fêmea

Codigo	Med. Ext.	Ø	Côr	Preço
29,1110	20 x 1/2"	1/2" x 1/2"	verm.	5,06 €
29,1111	25 x 3/4"	3/4" x 3/4"	verm.	6,70 €
29,1112	32 x 1"	1" x 1"	verm.	10,05 €
29,1113	20 x 1/2"	1/2" x 1/2"	azul	4,60 €
29,1114	25 x 3/4"	3/4" x 3/4"	azul	6,08 €
29,1115	32 x 1"	1" x 1"	azul	9,14 €

Junção soldar roscar macho

Codigo	Med. Ext.	Ø	Côr	Preço
29,1120	20 x 1/2"	1/2" x 1/2"	verm.	5,38 €
29,1121	25 x 3/4"	3/4" x 3/4"	verm.	7,10 €
29,1122	32 x 1"	1" x 1"	verm.	10,30 €
29,1123	20 x 1/2"	1/2" x 1/2"	azul	4,86 €
29,1124	25 x 3/4"	3/4" x 3/4"	azul	6,48 €
29,1125	32 x 1"	1" x 1"	azul	9,38 €



Cruzeta redução

Codigo	Med. Ext.	Ø	Côr	Preço
29,1130	40x20x20x40	1/4"x1/2"x1.1/4"	verm.	7,59 €
29,1131	40x25x25x40	1/4"x3/4"x1.1/4"	verm.	7,59 €

Curvas 90° fêmea

Codigo	Med. Ext.	Ø	Côr	Preço
29,1132	20	1/2"	verm.	2,40 €
29,1133	25	3/4"	verm.	2,86 €

Joelho 3 vias

Codigo	Med. Ext.	Ø	Côr	Preço
29,1134	20	1/2"	verm.	0,46 €



Tês redução

Codigo	Med. Ext.	Ø	Côr	Preço
29,1135	20x16x20	1/2" x 3/8" x 1/2"	verm.	0,46 €
29,1136	20x20x16	1/2" x 1/2" x 3/8"	verm.	0,46 €
29,1137	25x16x25	3/4" x 3/8" x 3/4"	verm.	0,46 €
29,1138	25x20x20	3/4" x 1/2" x 1/2"	verm.	0,46 €
29,1139	25x20x25	3/4" x 1/2" x 3/4"	verm.	0,46 €
29,1140	25x25x20	3/4" x 3/4" x 1/2"	verm.	0,74 €
29,1141	32x20x25	1" x 1/2" x 3/4"	verm.	0,74 €
29,1142	32x20x32	1" x 1/2" x 1"	verm.	0,74 €
29,1143	32x25x32	1" x 3/4" x 1"	verm.	0,78 €
29,1144	32x32x25	1" x 1" x 3/4"	verm.	1,04 €
29,1145	40x20x40	1/4" x 1/2" x 1.1/4"	verm.	1,04 €
29,1146	40x25x40	1/4" x 3/4" x 1.1/4"	verm.	1,16 €
29,1147	40x32x40	1.1/4" x 1" x 1.1/4"	verm.	1,34 €
29,1148	50x20x50	1/2" x 1/2" x 1.1/2"	verm.	1,73 €
29,1149	50x25x50	1/2" x 3/4" x 1.1/2"	verm.	1,88 €
29,1150	50x32x50	1.1/2" x 1" x 1.1/2"	verm.	2,04 €
29,1152	25x20x25	3/4" x 1/2" x 3/4"	azul	0,43 €
29,1153	32x20x32	1" x 1/2" x 1"	azul	0,68 €
29,1154	32x25x32	1" x 3/4" x 1"	azul	0,71 €

Tês simples

Codigo	Med. Ext.	Ø	Côr	Preço
29,1155	16	3/8"	verm.	0,28 €
29,1156	20	1/2"	verm.	0,28 €
29,1157	25	3/4"	verm.	0,53 €
29,1158	32	1"	verm.	0,88 €
29,1159	40	1.1/4"	verm.	1,55 €
29,1160	50	1.1/2"	verm.	2,78 €
29,1161	63	2"	verm.	4,71 €
29,1162	20	1/2"	azul	0,34 €
29,1163	25	3/4"	azul	0,47 €
29,1164	32	1"	azul	0,78 €

Tês roscados fêmea

Codigo	Med. Ext.	Ø	Côr	Preço
29,1165	20 x 1/2" x 20	1/2" x 1/2" x 1/2"	verm.	2,69 €
29,1166	25x1/2"x25	3/4" x 1/2" x 3/4"	verm.	3,18 €
29,1167	25x3/4"x25	3/4" x 3/4" x 3/4"	verm.	3,74 €
29,1168	32x1/2"x32	1" x 1/2" x 1"	verm.	3,48 €
29,1169	32x3/4"x32	1" x 3/4" x 1"	verm.	4,29 €
29,1170	32x1"x32	1" x 1" x 1"	verm.	7,68 €
29,1171	20 x 1/2" x 20	1/2" x 1/2" x 1/2"	azul	2,44 €
29,1172	25x1/2"x25	3/4" x 1/2" x 3/4"	azul	2,87 €
29,1173	25x3/4"x25	3/4" x 3/4" x 3/4"	azul	3,40 €
29,1174	32x1"x32	1" x 1" x 1"	azul	6,98 €

Nota: Esta tabela pode ser alterada sem aviso prévio, preços sujeitos à taxa de I.v.a. em vigor.

Setúbal, 01 de Janeiro de 2018.

Pág.: 87



Hidrosado, Lda.
 Quinta Varzinha, Lote 25
 2900-721 Setúbal
 Telefone: 265537550
 Fax: 265537551
 Mail: geral@hidrosado.pt
 Site: www.hidrosado.pt

Acessórios P.P.R.

Joelho roscado fêmea c/pater



Codigo	Med. Ext.	Ø	Côr	Preço
29,1255	20 x 3/8"	1/2" x 3/8"	verm.	2,84 €
29,1256	20 x 1/2"	1/2" x 1/2"	verm.	2,84 €
29,1257	20 x 1/2"	1/2" x 1/2"	azul	2,58 €

Suporte fixação



Codigo	Med. Ext.	Ø	Côr	Preço
29,1250	20 x 1/2"	1/2" x 1/2"	verm.	10,64 €
29,1251	25 x 1/2"	3/4" x 1/2"	verm.	15,53 €

Torneira corte castelo - curto



Codigo	Med. Ext.	Ø	Côr	Preço
29,1341	20	1/2"	verm.	9,16 €
29,1342	25	3/4"	verm.	12,26 €
29,1343	32	1"	verm.	12,36 €
29,1344	20	1/2"	azul	9,63 €
29,1345	25	3/4"	azul	10,89 €
29,1346	32	1"	azul	14,34 €

Torneira corte castelo (comprido)



Codigo	Med. Ext.	Ø	Côr	Preço
29,1347	20	1/2"	azul	17,89 €
29,1348	25	3/4"	azul	20,65 €
29,1349	32	1"	azul	21,28 €

Torneira corte (esfera)



Codigo	Med. Ext.	Ø	Côr	Preço
29,1353	20	1/2"	verm.	25,90 €
29,1354	25	3/4"	verm.	27,07 €
29,1355	32	1"	verm.	30,19 €

Espelho e castelo normal



Codigo	Med. Ext.	Ø	Côr	Preço
29,1295	-	1/2"	verm.	11,46 €
29,1296	-	3/4"	verm.	13,05 €



Torneira corte castelo c/punho

Codigo	Med. Ext.	Ø	Côr	Preço
29,1260	20	1/2"	verm.	15,66 €
29,1261	25	3/4"	verm.	16,86 €
29,1262	32	1"	verm.	17,46 €
29,1263	20	1/2"	azul	15,46 €
29,1264	25	3/4"	azul	16,56 €
29,1265	32	1"	azul	17,16 €

Corpo de torneira

Codigo	Med. Ext.	Ø	Côr	Preço
29,1270	20	1/2"	verm.	2,28 €
29,1271	25	3/4"	verm.	3,46 €
29,1272	32	1"	verm.	4,10 €
29,1273	20	1/2"	azul	2,08 €
29,1274	25	3/4"	azul	3,10 €
29,1275	32	1"	azul	3,73 €

Tampão

Codigo	Med. Ext.	Ø	Côr	Preço
29,1280	16	3/8"	verm.	0,14 €
29,1281	20	1/2"	verm.	0,15 €
29,1282	25	3/4"	verm.	0,24 €
29,1283	32	1"	verm.	0,41 €
29,1284	40	1.1/4"	verm.	0,86 €
29,1285	50	1.1/2"	verm.	1,28 €
29,1286	63	2"	verm.	2,45 €
29,1287	20	1/2"	azul	0,14 €
29,1288	25	3/4"	azul	0,23 €
29,1289	32	1"	azul	0,36 €

Tampão macho

Codigo	Med. Ext.	Ø	Côr	Preço
29,1290	-	1/2"	verm.	0,16 €
29,1291	-	3/4"	verm.	0,24 €
29,1292	-	1/2"	azul	0,15 €
29,1293	-	3/4"	azul	0,21 €

Nota: Esta tabela pode ser alterada sem aviso prévio, preços sujeitos à taxa de I.v.a. em vigor.
 Setúbal, 01 de Janeiro de 2018.



Hidrosado, Lda.
 Quinta Varzinha, Lote 25
 2900-721 Setúbal
 Telefone: 265537550
 Fax: 265537551
 Mail: geral@hidrosado.pt
 Site: www.hidrosado.pt

Acessórios P.P.R.

Espelho e castelo comprido

Codigo	Ø	Preço
29,1300	½"	15,96 €
29,1301	¾"	17,96 €



Flange

Codigo	Med. Ext.	Ø	Preço
29,1320	32	1"	9,62 €
29,1321	40	1.¼"	15,33 €
29,1322	50	1.½"	16,71 €
29,1323	63	2"	17,86 €
29,1324	75	2.½"	23,92 €
29,1325	90	3"	27,12 €



Colarinho

Codigo	Med. Ext.	Ø	Côr	Preço
29,1305	32	1"	verm.	2,79 €
29,1306	40	1.¼"	verm.	3,30 €
29,1307	50	1.½"	verm.	3,73 €
29,1308	63	2"	verm.	6,14 €
29,1309	75	2.½"	verm.	7,78 €
29,1310	90	3"	verm.	21,76 €



Corta tubos

Codigo	Med. Ext.	Ø	Preço
29,1330	-	50 - 110	122,18 €



Tesouras

Codigo	-	Ø	Preço
29,1316	1	16 - 40	11,32 €

1



Polifusora c/caixa e matrizes

Codigo	-	Ø	Preço
29,1336	1	20 - 32	153,89 €

1



Nota: Esta tabela pode ser alterada sem aviso prévio, preços sujeitos à taxa de I.v.a. em vigor.
 Setúbal, 01 de Janeiro de 2018.



Hidrosado, Lda.

Quinta Varzinha, Lote 25

2900-721 Setúbal

Telefone: 265537550

Fax: 265537551

Mail: geral@hidrosado.pt

Site: www.hidrosado.pt

Válvulas de esfera

Tabela de válvulas

Código	Válvulas de esfera fêmeas	Preço
09.2010	1/2"	3,88 €
09.2011	3/4"	5,47 €
09.2012	1"	8,63 €
09.2013	1.1/4"	15,20 €
09.2014	1.1/2"	20,67 €
09.2015	2"	34,04 €
09.2016	2.1/2"	67,11 €
09.2017	3"	97,27 €
09.2018	4"	162,91 €



Código	Válvulas de esfera m/f	Preço
09.2035	1/2"	4,01 €
09.2026	3/4"	6,75 €
09.2027	1"	9,49 €
09.2028	1.1/4"	15,80 €
09.2029	1.1/2"	21,28 €
09.2030	2"	34,65 €
09.2031	2.1/2"	67,11 €
09.2032	3"	97,27 €



Código	Válvulas de esfera p/água c/fechadura	Preço
09.2052	1"	46,80 €



Código	Válvulas de esfera com borboleta	Preço
09,2038	1/2"	3,88 €
09,2039	3/4"	5,53 €
09,2040	1"	9,25 €



Código	Torneiras de esfera c/junção	Preço
09.2019	1/2"	5,71 €
09.2020	3/4"	7,54 €
09.2021	1"	12,16 €



Código	Recordes para válvulas	Preço
09,2022	1/2"	1,26 €
09,2023	3/4"	1,94 €
09,2024	1"	4,33 €



Nota: Esta tabela pode ser alterada sem aviso prévio, preços sujeitos à taxa de I.v.a. em vigor.
Setúbal, 01 de Janeiro de 2018.



Hidrosado, Lda.
 Quinta Varzinha, Lote 25
 2900-721 Setúbal
 Telefone: 265537550
 Fax: 265537551
 Mail: geral@hidrosado.pt
 Site: www.hidrosado.pt

Válvulas Chupadoras e de Retenção



Tabela de válvulas		
Código	Válvulas chupadoras Italianas c/batente latão	Preço
09.1180	¾"	6,96 €
09.1014	1"	8,13 €
09.1015	1.¼"	11,64 €
09.1016	1.½"	13,30 €
09.1017	2"	21,27 €
09.1018	2.½"	45,60 €
09.1019	3"	85,00 €
Código	Válvulas retenção Italianas c/batente latão	
09.1181	¾"	6,05 €
09.1049	1"	8,08 €
09.1050	1.¼"	11,57 €
09.1051	1.½"	17,07 €
09.1052	2"	25,46 €
09.1053	2.½"	57,97 €
09.1054	3"	74,72 €
Código	Válvulas retenção c/janela	
09.1065	1"	10,27 €
09.1066	1.¼"	16,05 €
09.1067	1.½"	20,80 €
09.1068	2"	38,42 €
09.1108	2.½"	59,09 €
09.1109	3"	87,80 €
Código	Filtros p/válvulas chupadoras	
09.1182	¾"	1,65 €
09.1101	1"	1,99 €
09.1102	1.¼"	2,33 €
09.1103	1.½"	2,65 €
09.1104	2"	3,93 €
09.1105	2.½"	6,59 €
09.1106	3"	8,23 €
09.1107	4"	20,11 €
Código	Filtros areia em latão	
09.1060	1"	8,73 €
09.1061	1.¼"	17,27 €
09.1062	1.½"	21,76 €
09.1063	2"	37,34 €
09.1111	2.½"	78,38 €
09.1128	3"	91,55 €
Código	Válvulas de retenção tipo Europa c/batente inox	
09.1183	½"	5,60 €
09.1184	¾"	7,99 €
09.1095	1"	12,42 €
09.1096	1.¼"	19,08 €
09.1097	1.½"	26,01 €
09.1098	2"	38,65 €
09.1080	2.½"	88,70 €
09.1099	3"	124,76 €
09.1084	4"	189,96 €
Código	Válvulas retenção artesiana inox	
09.2065	1.¼"	54,12 €
09.2067	1.½"	74,50 €
09.2066	2"	119,40 €

Nota: Esta tabela pode ser alterada sem aviso prévio, preços sujeitos à taxa de I.v.a. em vigor.
 Setúbal, 01 de Janeiro de 2018.



Hidrosado, Lda.

Quinta Varzinha, Lote 25

2900-721 Setúbal

Telefone: 265537550

Fax: 265537551

Mail: geral@hidrosado.pt

Site: www.hidrosado.pt

Acessórios GEKA



Código *Junções Swift/Geka mangueira* **Preço**

09.4008	1/2"	3,53 €
09.4009	3/4"	3,85 €
09.4010	1"	4,25 €
09.4019	1.1/4"	5,50 €
09.4020	1.1/2"	6,94 €



Código *Junções Swift/Geka macho*

09.4014	1/2"	3,05 €
09.4017	3/4"	3,38 €
09.4016	1"	3,70 €
09.4024	1.1/4"	4,71 €
09.4025	1.1/2"	5,71 €



Código *Junções Swift/Geka fêmea*

09.4011	1/2"	3,45 €
09.4012	3/4"	3,56 €
09.4013	1"	3,86 €
09.4026	1.1/4"	4,97 €
09.4027	1.1/2"	6,33 €



Código *Tampão Swift/Geka latão*

09.4015



Código *Tês Swift/Geka de 3 saídas*

09.4021



Código *Borrachas para Swift/Geka*

09.4022 0,72 €

Nota: Esta tabela pode ser alterada sem aviso prévio, preços sujeitos à taxa de I.v.a. em vigor.
Setúbal, 01 de Janeiro de 2018.



Hidrosado, Lda.

Quinta Varzinha, Lote 25

2900-721 Setúbal

Telefone: 265537550

Fax: 265537551

Mail: geral@hidrosado.pt

Site: www.hidrosado.pt

Abraçadeiras



Abraçadeiras Hércules zincada

09,3000	3/4"	0,65 €
09,3001	1"	0,67 €
09,3002	1.1/4"	0,68 €
09,3003	1.1/2"	0,70 €
09,3004	2"	0,72 €
09,3005	2.1/2"	0,75 €
09,3006	3"	0,77 €
09,3007	4"	0,85 €



Abraçadeiras Hércules - Inox

09,3033	3/4"	1,95 €
09,3024	1"	2,03 €
09,3025	1.1/4"	2,13 €
09,3026	1.1/2"	2,22 €
09,3027	2"	2,32 €
09,3028	2.1/2"	2,40 €
09,3029	3"	2,52 €
09,3034	4"	2,73 €



Abraçadeiras tipo Algeroz Zincada - Espigão

09,3040	1/2"	0,25 €
09,3041	3/4"	0,28 €
09,3042	1"	0,32 €
09,3043	1.1/4"	0,35 €
09,3044	1.1/2"	0,38 €
09,3045	2"	0,43 €
09,3046	2.1/2"	0,55 €



Abraçadeiras tipo Algeroz Inox - Espigão

09,3060	1/2"	1,28 €
09,3061	3/4"	1,33 €
09,3062	1"	1,42 €
09,3063	1.1/4"	1,48 €
09,3064	1.1/2"	1,65 €
09,3065	2"	1,78 €
09,3066	2.1/2"	1,93 €



Abraçadeira Algeroz Zincada c/porca M8

09,3070	1/2"	0,33 €
09,3071	3/4"	0,35 €
09,3072	1"	0,38 €
09,3073	1.1/4"	0,42 €
09,3074	1.1/2"	0,47 €
09,3075	2"	0,50 €
09,3076	2.1/2"	0,62 €
09,3077	3"	0,70 €
09,3078	4"	0,80 €
09,3079	5"	0,88 €
09,3080	5.1/2"	0,93 €
09,3081	6"	1,20 €
09,3082	7.1/2"	1,83 €



Abraçadeira Algeroz Zincada c/porca M8 e revestimento

09,3085	1/2"	0,73 €
09,3086	3/4"	0,78 €
09,3087	1"	0,85 €
09,3088	1.1/4"	0,90 €
09,3089	1.1/2"	0,97 €
09,3090	2"	1,07 €
09,3091	2.1/2"	1,15 €
09,3092	3"	1,27 €
09,3093	4"	1,42 €
09,3094	5"	1,75 €
09,3095	5.1/2"	2,03 €
09,3096	6"	2,90 €
09,3097	7.1/2"	3,77 €



Abraçadeira de fita s/fim

09,3009	00 / A - 3 / 16	0,37 €
09,3010	0 / A - 1/4	0,37 €
09,3011	1 / A - 3/8	0,38 €
09,3012	1 - 1/2	0,40 €
09,3013	2 - 3/4	0,42 €
09,3014	2,5 - 7/8	0,43 €
09,3015	3 - 1"	0,47 €
09,3016	4 - 1.1/4"	0,48 €
09,3017	4,5 - 1.1/2"	0,52 €
09,3018	5,5 - 2"	0,57 €
09,3019	2.1/2"	0,58 €



Abraçadeiras de fita s/fim inox - 14mm

09,3050	1/2"	1,57 €
09,3051	3/4"	1,65 €
09,3052	1"	1,75 €
09,3053	1.1/4"	1,93 €
09,3054	1.1/2"	2,01 €
09,3055	2"	2,20 €

Nota: Esta tabela pode ser alterada sem aviso prévio, preços sujeitos à taxa de I.v.a. em vigor.

Setúbal, 01 de Janeiro de 2018.

Pág.: 93

Acessórios de Latão



Canhão macho		
Código	Medida	Preço
09,1038	½"	1,19 €
09,1039	¾"	1,55 €
09,1040	1"	2,02 €
09,1041	1.¼"	3,21 €
09,1042	1.½"	4,17 €
09,1043	2"	6,55 €
09,1044	2.½"	10,70 €
09,1045	3"	19,00 €
09,1046	4"	45,20 €



Canhão macho longo		
Código	Medida	Preço
09,1087	1"	4,30 €
09,1124	1.¼"	4,42 €
09,1125	1.½"	6,13 €
09,1010	2"	9,80 €
09,1011	2.½"	
09,1126	3"	



Canhão fêmea		
Código	Medida	Preço
09,1149	¾"	2,10 €
09,1150	½"	1,30 €
09,1151	¾"	1,71 €
09,1152	1"	2,45 €
09,1153	1.¼"	3,50 €
09,1154	1.½"	4,30 €
09,1155	2"	6,13 €



Válvula chupadora c/canhão		
Código	Medida	Preço
09,1135	¾"	13,09 €
09,1136	1"	13,09 €
09,1008	1.¼"	16,66 €
09,1001	1.½"	22,62 €
09,1002	2"	28,57 €
09,1009	2.½"	59,52 €
09,1013	3"	91,96 €



Canhões duplos		
Código	Medida	Preço
09,1117	¾"	2,57 €
09,1085	1"	3,68 €
09,1086	1.¼"	3,80 €
09,1090	1.½"	4,90 €
09,1100	2"	6,13 €



Válvula chupadora s/canhão		
Código	Medida	Preço
09,1138	1.½"	21,00 €
09,1139	2"	28,20 €



Junções S/C motor		
Código	Medida	Preço
09,1021	1"	7,62 €
09,1022	1.¼"	9,16 €
09,1023	1.½"	12,73 €
09,1024	2"	20,80 €
09,1025	2.½"	33,33 €
09,1026	3"	47,61 €
09,1027	4"	190,00 €
09,1028	5"	190,00 €



Junções duplas		
Código	Medida	Preço
09,1031	1"	8,58 €
09,1032	1.¼"	9,80 €
09,1033	1.½"	13,37 €
09,1034	2"	19,62 €
09,1035	2.½"	39,23 €
09,1036	3"	56,40 €



Junções S/C motor F/M		
Código	Medida	Preço
09,1160	1"	9,03 €
09,1159	1.¼"	9,75 €
09,1161	1.½"	15,33 €
09,1162	2"	20,84 €



Tê curvo de latão		
Código	Medida	Preço
13,2267	1.¼"	19,82 €
13,2269	2"	42,20 €



Junção depósito		
Código	Medida	Preço
09,1170	¾"	3,93 €
09,1172	1"	5,39 €
09,1171	1.¼"	7,36 €



Válvula artesiana fim de poço		
Código	Medida	Preço
09,1075	1"	8,27 €
09,1076	1.¼"	12,41 €
09,1077	1.½"	17,92 €
09,1078	2"	28,20 €



Batente		
Código	Medida	Preço
09,1132	1.¼"	1,67 €
09,1133	1.½"	2,27 €
09,1134	2"	4,29 €

Nota: Esta tabela pode ser alterada sem aviso prévio, preços sujeitos à taxa de I.v.a. em vigor.
 Setúbal, 01 de Janeiro de 2018.

Acessórios de Latão

Código	Medida	Preço
--------	--------	-------

Joelhos latão M/F 90°

13.2024	½"	1,38 €
13.2025	¾"	1,93 €
13.2026	1"	2,87 €
13.2027	1.¼"	4,73 €
13.2028	1.½"	5,88 €
13.2029	2"	9,20 €
13.2030	2.½"	19,61 €
13.2038	3"	33,22 €



Código	Medida	Preço
--------	--------	-------

Casquilhos duplos latão

13.2000	½"	0,69 €
13.2001	¾"	0,93 €
13.2002	1"	1,66 €
13.2003	1.¼"	2,46 €
13.2004	1.½"	3,40 €
13.2005	2"	4,84 €
13.2006	2.½"	11,79 €
13.2007	3"	13,43 €
13.2008	4"	42,23 €

Tês simples latão

13.2124	½"	1,75 €
13.2125	¾"	2,44 €
13.2127	1"	3,56 €
13.2128	1.¼"	6,01 €
13.2129	1.½"	8,47 €
13.2130	2"	11,15 €
13.2131	2.½"	21,30 €
13.2230	3"	39,24 €



Joelhos fêmea latão

13.2031	½"	1,31 €
13.2032	¾"	1,82 €
13.2033	1"	2,88 €
13.2034	1.¼"	4,62 €
13.2035	1.½"	6,03 €
13.2036	2"	9,58 €
13.2037	2.½"	16,21 €
13.2231	3"	28,59 €
13.2255	4"	78,19 €

Uniões simples latão

13.2136	¾"	2,39 €
13.2137	½"	1,19 €
13.2138	¾"	1,38 €
13.2140	1"	2,14 €
13.2141	1.¼"	3,55 €
13.2142	1.½"	4,42 €
13.2143	2"	6,93 €
13.2144	2.½"	10,18 €
13.2145	3"	16,30 €
13.2146	4"	47,82 €



Junções S/C fêmea

13.2091	½"	3,93 €
13.2092	¾"	4,77 €
13.2094	1"	6,15 €
13.2095	1.¼"	8,92 €
13.2096	1.½"	10,95 €
13.2097	2"	15,60 €
13.2098	2.½"	43,53 €
13.2099	3"	53,15 €
13.2100	4"	214,28 €

Curva com junção

13.2151	1"	14,40 €
13.2152	1.¼"	16,68 €
13.2153	1.½"	24,52 €
13.2154	2"	42,92 €



Tampões machos

13.2113	½"	0,48 €
13.2114	¾"	0,83 €
13.2116	1"	1,30 €
13.2117	1.¼"	2,06 €
13.2118	1.½"	2,45 €
13.2119	2"	3,74 €



Tampões fêmeas

13.2233	½"	0,49 €
13.2234	¾"	0,68 €
13.2235	1"	1,13 €
13.2236	1.¼"	2,19 €
13.2237	1.½"	2,85 €
13.2238	2"	3,83 €



Junções S/C M/F

13.2239	½"	5,27 €
13.2240	¾"	6,55 €
13.2241	1"	8,05 €
13.2242	1.¼"	10,03 €
13.2243	1.½"	13,33 €
13.2244	2"	16,66 €



Hidrosado, Lda.

Quinta Varzinha, Lote 25

2900-721 Setúbal

Telefone: 265537550

Fax: 265537551

Mail: geral@hidrosado.pt

Site: www.hidrosado.pt

Acessórios de Latão



Código	Medida	Preço
Curvas latão M/F 90°		
13.2018	1"	6,95 €
13.2019	1.¼"	12,79 €
13.2020	1.½"	14,98 €
13.2021	2"	26,19 €
13.2022	2.½"	47,82 €
13.2245	3"	91,96 €



Código	Medida	Preço
Unões redução M/F latão		
13.2175	¾" x ½"	1,37 €
13.2176	1" x ½"	2,09 €
13.2177	1" x ¾"	1,98 €
13.2178	1.¼" x ¾"	4,65 €
13.2179	1.¼" x 1"	4,73 €
13.2180	1.½" x ¾"	5,27 €
13.2181	1.½" x 1"	5,95 €
13.2182	1.½" x 1.¼"	3,86 €
13.2183	2" x ¾"	8,36 €
13.2184	2" x 1"	7,60 €
13.2185	2" x 1.¼"	7,60 €
13.2186	2" x 1.½"	7,79 €



Código	Medida	Preço
Curvas fêmeas latão 90°		
13.2011	1"	7,33 €
13.2012	1.¼"	13,62 €
13.2013	1.½"	15,97 €
13.2014	2"	26,19 €
13.2015	2.½"	49,04 €
13.2247	3"	91,96 €



Código	Medida	Preço
Tês redução Latão		
13.2187	¾" x ½"	2,44 €
13.2188	1" x ½"	3,41 €
13.2189	1" x ¾"	3,41 €
13.2190	1.¼" x ¾"	5,22 €
13.2191	1.¼" x 1"	5,22 €
13.2192	1.½" x ¾"	6,44 €
13.2193	1.½" x 1"	6,44 €
13.2194	1.½" x 1.¼"	6,54 €
13.2195	2" x ¾"	11,15 €
13.2196	2" x 1"	11,15 €
13.2197	2" x 1.¼"	11,15 €
13.2198	2" x 1.½"	11,21 €
13.2248	2.½" x 2"	23,80 €



Código	Medida	Preço
Porcas de redução		
13.2256	¾" x ¼"	0,60 €
13.2246	½" x ¼"	0,71 €
13.2225	¾" x ½"	0,71 €
13.2226	1" x ½"	1,49 €
13.2227	1" x ¾"	1,08 €
13.2155	1.¼" x ½"	2,29 €
13.2156	1.¼" x ¾"	2,29 €
13.2157	1.¼" x 1"	1,74 €
13.2158	1.½" x ½"	3,35 €
13.2159	1.½" x ¾"	3,14 €
13.2160	1.½" x 1"	3,14 €
13.2161	1.½" x 1.¼"	2,32 €
13.2162	2" x ½"	4,53 €
13.2163	2" x ¾"	4,53 €
13.2164	2" x 1"	4,53 €
13.2165	2" x 1.¼"	4,53 €
13.2166	2" x 1.½"	3,74 €
13.2167	2.½" x ¾"	11,90 €
13.2168	2.½" x 1"	11,90 €
13.2169	2.½" x 1.¼"	11,90 €
13.2170	2.½" x 1.½"	10,71 €
13.2171	2.½" x 2"	10,71 €
13.2172	3" x 1.½"	13,49 €
13.2173	3" x 2"	13,49 €
13.2174	3" x 2.½"	13,49 €



Código	Medida	Preço
Unões redução F/F latão		
13.2199	¾" x ½"	1,38 €
13.2200	1" x ½"	2,20 €
13.2201	1" x ¾"	2,03 €
13.2202	1.¼" x ¾"	3,50 €
13.2203	1.¼" x 1"	3,50 €
13.2204	1.½" x ¾"	5,27 €
13.2205	1.½" x 1"	4,53 €
13.2206	1.½" x 1.¼"	3,79 €
13.2207	2" x ¾"	7,89 €
13.2208	2" x 1"	7,89 €
13.2209	2" x 1.¼"	6,82 €
13.2210	2" x 1.½"	6,82 €



Código	Medida	Preço
Unões cruzamento		
13.2149	½"	3,80 €
13.2150	¾"	5,60 €
13.2249	1"	7,53 €



Código	Medida	Preço
Valvulas de cunha		
09,2034	½"	4,83 €
09,2000	¾"	6,08 €
09,2001	1"	17,62 €
09,2002	1.¼"	12,86 €
09,2003	1.½"	16,80 €
09,2004	2"	29,39 €
09,2005	2.½"	53,19 €
09,2006	3"	89,91 €
09,2007	4"	145,64 €

Nota: Esta tabela pode ser alterada sem aviso prévio, preços sujeitos à taxa de I.v.a. em vigor.

Setúbal, 01 de Janeiro de 2018.

Pág.: 96



Hidrosado, Lda.

Quinta Varzinha, Lote 25

2900-721 Setúbal

Telefone: 265537550

Fax: 265537551

Mail: geral@hidrosado.pt

Site: www.hidrosado.pt

Acessórios de Latão



Joelhos de red. latão

Código	Medida	Preço
13,2270	¾ x ½"	1,82 €
13,2271	1" x ½"	2,59 €
13,2272	1" x ¾"	2,59 €
13,2273	1.¼" x ½"	4,01 €
13,2274	1.¼" x ¾"	4,01 €
13,2275	1.¼" x 1"	4,01 €
13,2276	1.½" x ½"	3,86 €
13,2277	1.½" x ¾"	6,01 €
13,2278	1.½" x 1"	6,01 €
13,2279	1.½" x 1.¼"	6,01 €
13,2281	2" x ¾"	7,14 €
13,2282	2" x 1"	7,14 €



Válvulas redutoras de pressão

Código	Medida	Preço
20,1056	½"	29,88 €
20,1027	¾"	32,73 €
20,1057	1"	52,55 €
20,1055	1.¼"	86,90 €
20,1058	1.½"	89,88 €
20,1059	2"	165,47 €



Canhões aço inox c/argolas

Código	Medida	Preço
09,4001	1.¼"	27,46 €
09,4003	2"	37,40 €
09,4004	2.½"	56,70 €
09,4005	3"	65,60 €
09,4006	1.¼" c/roscas	27,46 €
09,4007	2" c/roscas	37,40 €



Canhões latão c/argolas

Código	Medida	Preço
20,1111	1.¼"	13,22 €
20,1112	1.½"	20,66 €
20,1113	2"	27,22 €



Casquilhos duplos red.

Código	Medida	Preço
13,2292	⅜" x ¼"	0,95 €
13,2250	½ x ¼"	1,07 €
13,2253	¾ x ½"	0,95 €
13,2251	1" x ½"	1,55 €
13,2211	1" x ¾"	1,55 €
13,2252	1.¼" x ½"	2,62 €
13,2212	1.¼" x ¾"	2,62 €
13,2213	1.¼" x 1"	2,62 €
13,2214	1.½" x ¾"	3,40 €
13,2215	1.½" x 1"	4,10 €
13,2216	1.½" x 1.¼"	3,93 €
13,2217	2" x ¾"	5,50 €
13,2218	2" x 1"	5,50 €
13,2219	2" x 1.¼"	5,50 €
13,2220	2" x 1.½"	5,50 €
13,2221	2.½" x 1.¼"	11,90 €
13,2222	2.½" x 1.½"	11,90 €
13,2223	2.½" x 2"	11,90 €
13,2224	3" x 2.½"	16,56 €



Ligação de depósito

Código	Medida	Preço
20,1115	¾" x ½"	3,80 €
20,1116	1" x ¾"	4,90 €
20,1117	1.¼" x 1"	7,05 €
20,1118	1.½" x 1.¼"	8,89 €
20,1119	2" x 1.½"	12,14 €



Cruzetas de latão

Código	Medida	Preço
13,2260	½"	3,00 €
13,2261	¾"	4,17 €
13,2262	1"	5,88 €
13,2263	1.¼"	9,93 €
13,2264	1.½"	12,08 €
13,2265	2"	19,62 €

União latão M/F

Código	Medida	Preço
13,2285	½"	0,96 €
13,2286	¾"	1,52 €
13,2287	1"	2,39 €
13,2288	1.¼"	4,63 €
13,2289	1.½"	5,14 €
13,2290	2"	7,48 €



Nota: Esta tabela pode ser alterada sem aviso prévio, preços sujeitos à taxa de I.v.a. em vigor.

Setúbal, 01 de Janeiro de 2018.

Pág.: 97



Hidrosado, Lda.

Quinta Varzinha, Lote 25

2900-721 Setúbal

Telefone: 265537550

Fax: 265537551

Mail: geral@hidrosado.pt

Site: www.hidrosado.pt

Acessórios de Inox

AISI 316

União F - F



Código	Ø	Preço
13,2300	½"	3,03 €
13,2301	¾"	4,27 €
13,2302	1"	5,52 €
13,2303	1.¼"	8,00 €
13,2304	1.½"	9,24 €
13,2305	2"	13,38 €

TÊ F - F



Código	Ø	Preço
13,2310	½"	3,72 €
13,2311	¾"	6,14 €
13,2312	1"	10,00 €
13,2313	1.¼"	14,62 €
13,2314	1.½"	19,99 €
13,2315	2"	28,27 €

Tampão F



Código	Ø	Preço
13,2320	½"	2,34 €
13,2321	¾"	2,69 €
13,2322	1"	4,55 €
13,2323	1.¼"	6,76 €
13,2324	1.½"	9,03 €
13,2325	2"	14,69 €

Tampão M



Código	Ø	Preço
13,2330	½"	2,14 €
13,2331	¾"	2,62 €
13,2332	1"	4,00 €
13,2333	1.¼"	6,27 €
13,2334	1.½"	7,58 €
13,2335	2"	11,65 €

Joelho F - F



Código	Ø	Preço
13,2340	½"	2,62 €
13,2341	¾"	4,21 €
13,2342	1"	7,24 €
13,2343	1.¼"	10,82 €
13,2344	1.½"	15,65 €
13,2345	2"	22,06 €

Casquilho duplo M - M



Código	Ø	Preço
13,2350	½"	2,62 €
13,2351	¾"	3,65 €
13,2352	1"	5,45 €
13,2353	1.¼"	8,24 €
13,2354	1.½"	11,17 €
13,2355	2"	14,27 €

Junção S/C F - F



Código	Ø	Preço
13,2360	½"	9,17 €
13,2361	¾"	12,48 €
13,2362	1"	17,30 €
13,2363	1.¼"	27,79 €
13,2364	1.½"	32,96 €
13,2365	2"	52,88 €

Casquilho duplo Redução M - M



Código	Ø	Preço
13,2370	¾" x ½"	4,48 €
13,2371	1" x ¾"	6,48 €
13,2372	1.¼" x 1"	7,79 €
13,2373	1.½" x 1.¼"	9,51 €
13,2374	2" x 1.½"	14,82 €

Porca Redução M - F



Código	Ø	Preço
13,2380	¾" x ½"	2,96 €
13,2381	1" x ¾"	3,86 €
13,2382	1.¼" x 1"	5,45 €
13,2383	1.½" x 1"	7,86 €
13,2384	1.½" x 1.¼"	6,21 €
13,2385	2" x 1"	13,58 €
13,2386	2" x 1.½"	11,72 €

Canhão macho



Código	Ø	Preço
13,2390	½"	3,86 €
13,2391	¾"	6,14 €
13,2392	1"	8,27 €
13,2393	1.¼"	12,76 €
13,2394	1.½"	17,37 €
13,2395	2"	25,30 €

Junção S/C M - F



Código	Ø	Preço
13,2400	½"	10,41 €
13,2401	¾"	12,41 €
13,2402	1"	18,82 €
13,2403	1.¼"	29,23 €
13,2404	1.½"	38,13 €
13,2405	2"	49,16 €

Nota: Esta tabela pode ser alterada sem aviso prévio, preços sujeitos à taxa de I.v.a. em vigor.

Setúbal, 01 de Janeiro de 2018.

Pág.: 98



Hidrosado, Lda.

Quinta Varzinha, Lote 25

2900-721 Setúbal

Telefone: 265537550

Fax: 265537551

Mail: geral@hidrosado.pt

Site: www.hidrosado.pt

Acessórios diversos

Código	Medida	Preço
--------	--------	-------

Tubos Flexíveis

07,5008	60cm x 1"	14,00 €
07,5012	80cm x 1"	15,20 €
07,5009	60cm x 1.¼"	27,50 €
07,5013	80cm x 1.¼"	31,00 €
07,5010	60cm x 1.½"	40,50 €
07,5014	80cm x 1.½"	45,00 €
07,5011	60cm x 2"	52,00 €
07,5015	80cm x 2"	58,00 €

Tubos Flexíveis c/curva

07,5017	60cm x 1"	19,00 €
07,5016	80cm x 1"	21,50 €

Tubos Flexíveis em inox

07,5020	60cm x 1"	21,00 €
07,5021	100cm x 1"	26,00 €
07,5022	60cm x 1.¼"	39,00 €
07,5023	100cm x 1.¼"	46,68 €
07,5024	100cm x 1.½"	68,40 €
07,5025	100cm x 2"	100,97 €

Boiador c/guia

20.1015	½"	14,28 €
20.1016	¾"	17,85 €
20.1017	1"	22,61 €
20.1018	1.¼"	45,10 €
20.1019	1.½"	58,89 €
20.1020	2"	77,38 €

Solas p/ válvulas chupadoras

20,1036	1"	0,90 €
20,1032	1.¼"	1,42 €
20,1037	1.½"	1,98 €
20,1038	2"	2,38 €
20,1039	2.½"	2,86 €

Código	Medida	Preço
--------	--------	-------

Latas de massa STOPOX

20,1067	50gr	2,93 €
20.1041	250gr	5,92 €
20.1040	500gr	8,88 €

Manipúlos p/ válvulas de esfera

20.2150	1"	3,80 €
20,2151	1.¼"	3,90 €
20.1043	1.½"	4,90 €
20.1042	2"	5,60 €
20,1044	3"	26,00 €

Máquina de Abraçadeiras

20,1006		143,78 €
---------	--	----------

Rolos de fita Inox

20.1008	¾"	30,37 €
20.1007	½"	39,68 €
20.1009	⅝"	47,32 €
20.1010	¾"	56,60 €

Caixas de fivelas Inox

20.1012	¾"	16,73 €
20.1011	½"	23,95 €
20.1013	⅝"	29,24 €
20.1014	¾"	36,25 €

Válvula segurança 4 funções

20,1005	¾"	34,00 €
---------	----	---------

Válvula segurança e retenção

20,1125	½"	6,60 €
20,1126	¾"	8,20 €



Nota: Esta tabela pode ser alterada sem aviso prévio, preços sujeitos à taxa de I.v.a. em vigor.

Setúbal, 01 de Janeiro de 2018.

Pág.: 99



Hidrosado, Lda.

Quinta Varzinha, Lote 25

2900-721 Setúbal

Telefone: 265537550

Fax: 265537551

Mail: geral@hidrosado.pt

Site: www.hidrosado.pt

Acessórios diversos



Código Medida Preço

Cola TANGIT p/ PVC

20.2027	250g	9,69 €
20.2028	500g	13,94 €

Diluyente p/ PVC

20.2031	500g	9,80 €
---------	------	--------

Tampas de furo em aço inox

20.2021	1.¼"	38,00 €
20.2022	2"	42,00 €
20.2024	3"	60,95 €

Corda de nylon - 12mm

20.2160	50 mts - 12mm	38,52 €
20.2161	100 mts - 12 mm	63,85 €
20.2162	100 mts - 14mm	79,83 €
20.2165	150mts - 14mm	112,00 €
20.2166	200mts - 14mm	156,00 €

Corda de nylon - Mts

20.2026	Metro	0,98 €
---------	-------	--------

Falange inferior autoclave

07.1021	Zincada 1"	8,90 €
07.1022	Zincada 1.½"	33,80 €

Falange superior autoclave

07.1023	< 100	21,32 €
07.1024	> 200	22,62 €

Válvula segurança M/F

20.1085	½" x 3 bar	5,91 €
20.1086	½" x 6 bar	5,91 €
20.1087	½" x 8 bar	10,24 €



Código Medida Preço

TEFLON

20.1034	Rolo Pequeno	0,48 €
20.1033	Rolo grande	4,94 €

Válvulas Anti-cálcario

20.1071	½"	183,00 €
20.1072	¾"	220,00 €
20.1073	1"	268,00 €
20.1074	1.¼"	392,00 €
20.1075	1.½"	507,00 €
20.1076	2"	615,00 €

LINHO

20.1100	Linho	3,77 €
---------	-------	--------

Bombas JOHNSON - 12V

04.5001	L 450	45,15 €
04.5002	L 550	62,63 €
04.5003	L 750	91,00 €

Ventosas de ar

20.3071	1"	11,25 €
20.3072	2"	35,69 €

Adaptadores para Deposito

20.0625	Fêmea 1.½"	8,92 €
20.0626	Fêmea 2"	8,92 €
20.0645	Macho 1.½"	5,00 €
20.0646	Macho 2"	5,00 €

Boca de incêndio T/C

20.1081	2" x 45	43,64 €
---------	---------	---------

Boca de incêndio

20.1080	1.½" x 45	41,67 €
---------	-----------	---------

Nota: Esta tabela pode ser alterada sem aviso prévio, preços sujeitos à taxa de I.v.a. em vigor.

Setúbal, 01 de Janeiro de 2018.

Pág.: 100



Hidrosado, Lda.

Quinta Varzinha, Lote 25

2900-721 Setúbal

Telefone: 265537550

Fax: 265537551

Mail: geral@hidrosado.pt

Site: www.hidrosado.pt

Tubo Polietileno Baixa e Alta Densidade

Tubo Polietileno Baixa Densidade 4 kg - cm²

código	Ø	mm	Preço
12,1001	½"	16	0,21 €
12,1002	⅝"	20	0,25 €
12,1003	¾"	25	0,38 €
12,1004	1"	32	0,56 €
12,1005	1.¼"	40	0,79 €
12,1006	1.½"	50	1,18 €
12,1007	2"	63	1,67 €
12,1008	2.½"	75	2,28 €
12,1009	3"	90	3,31 €



Tubo Alta Densidade 8 Kg - cm²

código	Ø	Preço
12,1012	1" x 8Kg	0,76 €
12,1013	1.¼" x 8Kg	1,12 €
12,1014	1.½" x 8Kg	1,72 €
12,1015	2" x 8Kg	2,67 €
12,1016	2.½" x 8Kg	3,71 €
12,1017	3" x 8Kg	5,19 €

Tubo Alta Densidade 10 Kg - cm²

código	Ø	Preço
12,1020	¾" x 10Kg	0,62 €
12,1021	1" x 10Kg	0,88 €
12,1022	1.¼" x 10Kg	1,35 €
12,1023	1.½" x 10Kg	2,05 €
12,1024	2" x 10Kg	3,22 €
12,1025	2.½" x 10Kg	4,45 €
12,1026	3" x 10Kg	6,33 €

Tubo Alta Densidade 16 Kg - cm²

código	Ø	Preço
12,1030	1.¼" x 16Kg	1,76 €
12,1031	1.½" x 16Kg	2,75 €
12,1032	2" x 16Kg	4,32 €

Tubos Polietileno Alta Densidade CERTIFICADO

Tubo Alta Densidade 8 Kg - cm²

código	Ø	Preço
12,1040	1" x 8 Kg	0,92 €
12,1041	1.¼" x 8 Kg	1,40 €
12,1042	1.½" x 8 Kg	2,17 €
12,1043	2" x 8 Kg	3,45 €
12,1044	2.½" x 8 Kg	4,52 €
12,1045	3" x 8 Kg	6,99 €
12,1046	4" x 8 Kg	10,38 €



Tubo Alta Densidade 10 Kg - cm²

código	Ø	Preço
12,1050	¾" x 10Kg	0,71 €
12,1051	1" x 10Kg	1,10 €
12,1052	1.¼" x 10Kg	1,70 €
12,1053	1.½" x 10Kg	2,63 €
12,1054	2" x 10Kg	4,19 €
12,1055	2.½" x 10Kg	5,83 €
12,1056	3" x 10Kg	8,37 €
12,1057	4" x 10Kg	12,58 €

Tubo Alta Densidade 16 Kg - cm²

código	Ø	Preço
12,1060	1" x 16 Kg	1,67 €
12,1061	1.¼" x 16 Kg	2,60 €
12,1062	1.½" x 16 Kg	4,03 €
12,1063	2" x 16 Kg	6,38 €
12,1064	2.½" x 16 Kg	9,02 €
12,1065	3" x 16 Kg	13,05 €
12,1066	4" x 16 Kg	19,38 €



Nota: Esta tabela pode ser alterada sem aviso prévio, preços sujeitos à taxa de I.v.a. em vigor.
Setúbal, 01 de Janeiro de 2018.



Hidrosado, Lda.

Quinta Varzinha, Lote 25

2900-721 Setúbal

Telefone: 265537550

Fax: 265537551

Mail: geral@hidrosado.pt

Site: www.hidrosado.pt

Tubos de Jardim

Tubo Jardim Baquelite Liz



FR - Verde e Amarelo

<i>código</i>	<i>Ø</i>	<i>d/int.</i>	<i>Preço</i>
12,1070	½"	12 mm	0,94 €
12,1071	⅝"	15 mm	1,01 €
12,1072	¾"	19 mm	1,40 €
12,1073	1"	25 mm	2,05 €
12,1074	1.¼"	32 mm	2,51 €

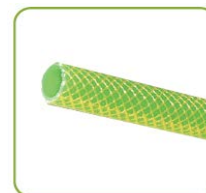

FR 2 - Verde Escuro

<i>código</i>	<i>Ø</i>	<i>d/int.</i>	<i>Preço</i>
12,1075	⅝"	15 mm	0,83 €
12,1076	¾"	19 mm	1,06 €
12,1077	1"	25 mm	1,43 €
12,1078	1.¼"	32 mm	2,33 €



Kit FR c/ acessórios

<i>código</i>	<i>Ø</i>	<i>mts</i>	<i>Preço</i>
12,1080	⅝"	15 Mts	12,86 €
12,1081	⅝"	25 Mts	18,43 €
12,1082	¾"	15 Mts	17,57 €
12,1083	¾"	25 Mts	27,14 €

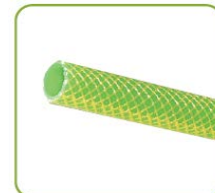

Tubo Jardim Heliflex

Heliflex

Gil

<i>código</i>	<i>Ø</i>	<i>d/int.</i>	<i>Preço</i>
12,7029	⅝"	15mm	1,28 €
12,7030	¾"	19mm	1,84 €
12,7031	1"	25mm	2,75 €



Amarelo - AM

<i>código</i>	<i>Ø</i>	<i>d/int.</i>	<i>Preço</i>
12,1085	½"	12 mm	1,21 €
12,1086	⅝"	15 mm	1,36 €
12,1087	¾"	19 mm	2,02 €
12,1088	1"	25 mm	3,24 €
12,1089	1.¼"	32 mm	4,47 €



Nota: Esta tabela pode ser alterada sem aviso prévio, preços sujeitos à taxa de I.v.a. em vigor.
Setúbal, 01 de Janeiro de 2018.



Hidrosado, Lda.
 Quinta Varzinha, Lote 25
 2900-721 Setúbal
 Telefone: 265537550
 Fax: 265537551
 Mail: geral@hidrosado.pt
 Site: www.hidrosado.pt

Tubos de Jardim

Tubo Jardim IBOTEC



Ibomaster Plus

<i>código</i>	<i>Rolo/Metros</i>	<i>Ø</i>	<i>d/int.</i>	<i>Preço/mt</i>
12,1260	25	½"	15 mm	1,00 €
12,1261	50	½"	15 mm	1,00 €
12,1263	25	¾"	19 mm	1,45 €
12,1264	50	¾"	19 mm	1,45 €
12,1265	25	1"	25 mm	2,19 €
12,1266	50	1"	25 mm	2,19 €



Musgo

<i>código</i>	<i>Metros</i>	<i>Ø</i>	<i>d/int.</i>	<i>Preço/mt</i>
12,1270	15	½"	15 mm	0,595 €
12,1271	25	½"	15 mm	0,595 €
12,1272	50	½"	15 mm	0,595 €
12,1273	25	¾"	19 mm	0,881 €
12,1274	50	¾"	19 mm	0,881 €
12,1275	25	1"	25 mm	1,309 €
12,1276	50	1"	25 mm	1,309 €
12,1277	50	1.¼"	32 mm	1,976 €



Savana

<i>código</i>	<i>Rolo/Metros</i>	<i>Ø</i>	<i>d/int.</i>	<i>Preço/mt</i>
12,1280	25	½"	15 mm	0,595 €
12,1281	50	½"	15 mm	0,597 €
12,1282	25	¾"	19 mm	0,857 €
12,1283	50	¾"	19 mm	0,859 €
12,1284	25	1"	25 mm	1,302 €
12,1285	50	1"	25 mm	1,302 €



Tubo cristal

<i>código</i>	<i>Kg</i>	<i>Ø</i>	<i>d/int.</i>	<i>Preço/Kg</i>
12,3049	1 KG	nível	8 mm	4,761 €
12,3050	1 KG	½"	12 mm	4,309 €
12,3051	1 KG	⅝"	15 mm	4,309 €
12,3052	1 KG	¾"	19 mm	4,119 €
12,3053	1 KG	1"	25 mm	4,119 €
12,3054	1 KG	1.¼"	32 mm	4,119 €
12,3055	1 KG	1.½"	40 mm	4,119 €
12,3056	1 KG	2"	50 mm	4,119 €



Nota: Esta tabela pode ser alterada sem aviso prévio, preços sujeitos à taxa de I.v.a. em vigor.
 Setúbal, 01 de Janeiro de 2018.



Hidrosado, Lda.

Quinta Varzinha, Lote 25

2900-721 Setúbal

Telefone: 265537550

Fax: 265537551

Mail: geral@hidrosado.pt

Site: www.hidrosado.pt

Tubos diversos

Tubo Sucção

Tubo chupador série ligeira

Verde claro - Rolos 7, 25 e 50 Mts



código	Ø	d/Int.	Preço
12,2110	1"	25 mm	2,83 €
12,2111	1.¼"	35 mm	3,86 €
12,2112	1.½"	42 mm	4,30 €
12,2113	2"	53 mm	5,50 €

Tubo chupador série pesada

Cinzento



código	d/Int.	Preço
12,2125	80 mm	27,94 €
12,2126	90 mm	31,66 €
12,2127	100 mm	39,80 €
12,2128	110 mm	46,28 €
12,2129	120 mm	48,69 €
12,2130	125 mm	50,55 €
12,2131	130 mm	55,95 €
12,2132	150 mm	76,07 €
12,2133	200 mm	124,08 €
12,2134	250 mm	176,33 €

Tubo Atóxico

Vermelho - Alimentar



código	Ø	d/Int.	Preço
12,7057	1"	35 mm	5,528 €
12,7058	1.¼"	40 mm	5,866 €
12,7059	1.½"	45 mm	6,849 €
12,7060	2"	50 mm	7,975 €
12,7075	2.½"	60 mm	12,142 €

Tubo piscina flexível PVC



código	Ø	Preço
12,7055	50mm	3,571 €
12,7056	63mm	5,785 €

Tubo chupador série média

Verde Opaco - Rolos 7, 25 e 50 Mts



código	Ø	d/Int.	Preço
12,2115	1"	25 mm	6,06 €
12,2116	1.¼"	35 mm	7,47 €
12,2117	1.½"	42 mm	8,77 €
12,2118	2"	53 mm	11,50 €
12,2119	2.½"	67 mm	10,66 €
12,2120	3"	78 mm	13,70 €
12,2121	4"	105 mm	28,43 €

Tubos galvanizados série média



código	Ø	d/ext.	Preço
12.6000	½"	21,1	3,86 €
12.6001	¾"	26,5	4,59 €
12.6002	1"	33,3	6,99 €
12.6003	1.¼"	42,0	8,80 €
12.6004	1.½"	47,9	10,16 €
12.6005	2"	59,7	14,68 €
12.6006	2.½"	75,3	18,28 €
12.6007	3"	88,0	23,80 €
12.6008	4"	113,1	36,50 €

Manga Agrícola - Heliflex



código	Ø	d/Int.	Preço
12,7047	1.½"	45mm	3,68 €
12,7048	2"	55mm	4,56 €
12,7049	2.½"	70 mm	6,51 €

Manga Agrícola

Flat - Azul



código	Ø	d/Int.	Preço
12,2150	1.½"	48 mm	1,739 €
12,2151	2"	58 mm	2,255 €
12,2152	3"	77 mm	2,835 €
12,2153	4"	102 mm	3,559 €
12,2154	6"	155 mm	9,729 €

Nota: Esta tabela pode ser alterada sem aviso prévio, preços sujeitos à taxa de I.v.a. em vigor.

Setúbal, 01 de Janeiro de 2018.

Pág.: 104



Hidrosado, Lda.
 Quinta Varzinha, Lote 25
 2900-721 Setúbal
 Telefone: 265537550
 Fax: 265537551
 Mail: geral@hidrosado.pt
 Site: www.hidrosado.pt

TUBO HIDROROSCADO PARA FURO EM PVC

Tube HOMOLOGADO para captação de água - Vara 6 mts

Código	Ø	Classe	Ø Externo mm	Espessura	Espessura	Ø Externo União		Pressão	Pressão	Preço €/mt
				parede tubo	na rosca	mm		interna	interna	
				mm	mm	Aço inox	PVC	bar	bar	
12,1300	1"¼	Standart	41,9	5,1	6,0	46,9	57,0	45	45	5,22 €
12,1301		Reforçado		6,1	7,0			60	60	6,50 €
12,1302	1"½	Standart	47,5	5,5	6,4	54,9	62,0	45	45	5,56 €
12,1303		Reforçado		6,5	7,4			60	60	6,94 €
12,1304	2"	Standart	59,6	6,4	7,3	66,1	80,3	45	45	7,33 €
12,1305		Reforçado		7,3	8,3			60	60	9,33 €
12,1306	2"½	Standart	74,5	6,9	7,8	81,5	98,0	45	45	8,87 €
12,1307		Reforçado		7,7	8,8			60	60	10,98 €
12,1308	3"	Standart	90,0	8,0	8,9	101,6	-	45	45	12,42 €
12,1309		Reforçado		8,7	9,9			60	60	15,00 €



União p/turbo Hidroroscado PVC

Código	Ø	Preço
12,1310	1"¼	2,82 €
12,1311	1"½	4,00 €
12,1312	2"	6,74 €
12,1313	2"½	10,20 €



Casquilho Transição Inox M/M 6 cm

Código	Ø	Preço
12,1325	1"¼	17,87 €
12,1326	1"½	18,98 €
12,1327	2"	21,96 €
12,1328	2"½	50,90 €
12,1329	3"	72,08 €



Canhão Inox Transição M/F

Código	Ø	Preço
12,1340	1"¼	50,00 €
12,1341	1"½	56,39 €
12,1342	2"	69,62 €
12,1343	2"½	83,31 €
12,1344	3"	123,67 €



União p/turbo Hidroroscado Latão

Código	Ø	Preço
12,1314	1"¼	10,35 €
12,1315	1"½	10,35 €
12,1316	2"	14,47 €
12,1317	2"½	17,59 €
12,1318	3"	24,70 €



Casquilho Transição Inox M/M 12 cm

Código	Ø	Preço
12,1330	1"¼	19,41 €
12,1331	1"½	21,66 €
12,1332	2"	23,77 €
12,1333	2"½	32,70 €
12,1334	3"	75,02 €



Válvula retenção

Código	Ø	Preço
12,1345	1"¼	23,53 €
12,1346	1"½	26,74 €
12,1347	2"	34,24 €
12,1348	2"½	40,65 €



União p/turbo Hidroroscado Inox

Código	Ø	Preço
12,1320	1"¼	29,79 €
12,1321	1"½	31,62 €
12,1322	2"	36,61 €
12,1323	2"½	49,90 €
12,1324	3"	120,14 €



Abraçadeira

Código	Ø	Preço
13,1335	1"¼	32,50 €
13,1336	1"½	34,00 €
13,1337	2"	36,00 €
13,1338	2"½	36,90 €
13,1339	3"	44,00 €



Cachorro

Código	Ø	Preço
13,1350	1"¼	17,65 €
13,1351	1"½	18,82 €
13,1352	2"	21,18 €
13,1353	2"½	23,53 €
13,1354	3"	29,41 €



Nota: Esta tabela pode ser alterada sem aviso prévio, preços sujeitos à taxa de I.v.a. em vigor.
 Setúbal, 01 de Janeiro de 2018.



Hidrosado, Lda.

Quinta Varzinha, Lote 25

2900-721 Setúbal

Telefone: 265537550

Fax: 265537551

Mail: geral@hidrosado.pt

Site: www.hidrosado.pt

Tubos PVC

Tubo Hidronil p/Roscar

<i>código</i>	<i>Ø</i>	<i>d/ext.</i>	<i>Preço</i>
12.5000	½"	21,1	0,93 €
12.5001	¾"	26,5	1,33 €
12.5002	1"	33,3	2,04 €
12.5003	1.¼"	42,0	3,30 €
12.5004	1.½"	47,9	3,71 €
12.5005	2"	59,7	5,49 €
12.5006	2.½"	75,3	7,40 €
12.8012	3"	88,0	9,13 €



Tubo pressão PVC p/colar 6Kg

<i>código</i>	<i>d/externor</i>	<i>Preço</i>
12,4027	40mm	s/c
12,5060	50mm	s/c
12,5061	63mm	s/c
12,5062	75mm	s/c
12,5063	90mm	s/c
12,5064	110mm	s/c
12,5065	125mm	s/c
12,5066	140mm	s/c
12,5067	160mm	s/c
12,5068	200mm	s/c

Tubo Pressão PVC c/oringues 6Kg

<i>código</i>	<i>d/externor</i>	<i>Preço</i>
12,5026	50mm	2,10 €
12,5058	63mm	3,35 €
12,5030	75mm	3,95 €
12,5032	90mm	4,97 €
12,5034	110mm	5,62 €
12,5036	125mm	7,35 €
12,5038	140mm	9,22 €
12,5040	160mm	11,87 €
12,5042	200mm	18,18 €



Tubo pressão PVC p/colar 10Kg

<i>código</i>	<i>d/externor</i>	<i>Preço</i>
12,5078	25mm	0,76 €
12,4024	32mm	1,01 €
12,4045	40mm	1,53 €
12,5069	50mm	2,41 €
12,5070	63mm	3,54 €
12,5071	75mm	4,69 €
12,5072	90mm	6,70 €
12,5073	110mm	7,98 €
12,5074	125mm	9,59 €
12,5075	140mm	11,89 €
12,5076	160mm	15,54 €
12,5077	200mm	24,96 €

Tubo Pressão PVC c/oringues 10Kg

<i>código</i>	<i>d/externor</i>	<i>Preço</i>
12,5027	50mm	2,32 €
12,5029	63mm	3,65 €
12,5031	75mm	5,22 €
12,5033	90mm	7,45 €
12,5035	110mm	8,98 €
12,5037	125mm	11,60 €
12,5039	140mm	14,60 €
12,5041	160mm	19,10 €
12,5043	200mm	29,42 €



Tubo Esgoto Domestico c/oringue

<i>código</i>	<i>d/externor</i>	<i>Preço</i>
12,5045	32mm	1,33 €
12,5046	40mm	1,71 €
12,5047	50mm	2,35 €
12,5048	63mm	2,46 €
12,5049	75mm	3,53 €
12,5050	90mm	4,03 €
12,5051	110mm	5,27 €
12,5052	125mm	5,98 €

Nota: Esta tabela pode ser alterada sem aviso prévio, preços sujeitos à taxa de I.v.a. em vigor.
Setúbal, 01 de Janeiro de 2018.



Hidrosado, Lda.

Quinta Varzinha, Lote 25

2900-721 Setúbal

Telefone: 265537550

Fax: 265537551

Mail: geral@hidrosado.pt

Site: www.hidrosado.pt

Válvulas de Fundição



Código	Medida	Preço
--------	--------	-------

Válvula retenção bola roscada

33.1001	1"	42,05 €
33.1002	1.¼"	45,29 €
33.1003	1.½"	56,27 €
33.1004	2"	83,58 €
33.1005	2.½"	120,08 €
33.1006	3"	163,67 €



Código	Medida	Preço
--------	--------	-------

Válvula retenção c/capela Revest. Borracha

33.1045	50	86,27 €
33.1046	65	129,38 €
33.1047	80	161,72 €
33.1048	100	197,65 €
33.1049	125	305,48 €
33.1050	150	431,24 €
33.1051	200	574,03 €



Válvula retenção bola flangeada

33.1010	50	106,91 €
33.1011	65	140,34 €
33.1012	80	175,05 €
33.1013	100	229,12 €
33.1014	125	339,05 €
33.1015	150	436,43 €
33.1016	200	863,58 €
33.1017	250	1.492,69 €
33.1018	300	2.150,05 €



Válvula retenção de disco

33.1055	50	60,93 €
33.1056	65	85,05 €
33.1057	80	100,50 €
33.1058	100	126,77 €
33.1059	125	197,93 €
33.1060	150	275,50 €
33.1061	200	445,12 €
33.1062	250	641,08 €



Válvula de cunha elástica

33.1020	50	98,19 €
33.1021	65	120,77 €
33.1022	80	151,96 €
33.1023	100	187,08 €
33.1024	125	260,24 €
33.1025	150	343,81 €
33.1026	200	516,43 €
33.1027	250	772,03 €
33.1028	300	1.162,31 €



Filtro p/válvula retenção disco

33.1065	50	20,98 €
33.1066	65	25,60 €
33.1067	80	29,36 €
33.1068	100	39,24 €
33.1069	125	49,24 €
33.1070	150	62,03 €
33.1071	200	88,91 €
33.1072	250	124,27 €



Filtro em Y

33.1030	40	39,79 €
33.1031	50	65,91 €
33.1032	65	97,55 €
33.1033	80	113,84 €
33.1034	100	148,84 €
33.1035	125	211,55 €
33.1036	150	295,98 €
33.1037	200	522,41 €
33.1038	250	881,81 €
33.1039	300	1.304,38 €



Válvula retenção duplo prato Wafer

33.1075	50	38,53 €
33.1076	65	45,10 €
33.1077	80	59,84 €
33.1078	100	74,58 €
33.1079	125	100,62 €
33.1080	150	148,05 €
33.1081	200	250,36 €
33.1082	250	358,84 €
33.1083	300	512,65 €

Nota: Esta tabela pode ser alterada sem aviso prévio, preços sujeitos à taxa de I.v.a. em vigor.
Setúbal, 01 de Janeiro de 2018.



Hidrosado, Lda.

Quinta Varzinha, Lote 25

2900-721 Setúbal

Telefone: 265537550

Fax: 265537551

Mail: geral@hidrosado.pt

Site: www.hidrosado.pt

Válvulas de Fundição

Código	Medida	Preço
--------	--------	-------

Válvula retenção c/capela AISI316 Wafer

33.1101	50	66,84 €
33.1102	65	82,30 €
33.1103	80	106,63 €
33.1104	100	150,99 €
33.1105	125	194,05 €
33.1106	150	253,60 €
33.1107	200	471,55 €
33.1108	250	705,69 €



Código	Medida	Preço
--------	--------	-------

*Válvula borboleta Wafer
c/ Disco em F/F
c/volante redutor*

33.1140	200	213,31 €
33.1141	250	281,39 €
33.1142	300	381,79 €
33.1143	350	507,88 €
33.1144	400	986,07 €
33.1145	500	1.553,40 €



*Válvula borboleta Wafer
c/disco AISI316*

33.1110	50	39,32 €
33.1111	65	49,32 €
33.1112	80	55,16 €
33.1113	100	80,44 €
33.1114	125	112,23 €
33.1115	150	134,59 €
33.1116	200	242,72 €
33.1117	250	384,26 €
33.1118	300	601,15 €



Junta Anti-vibratória roscada

33.1150	¾"	18,46 €
33.1151	1"	21,01 €
33.1152	1.¼"	27,35 €
33.1153	1.½"	29,27 €
33.1154	2"	36,02 €

Junta Anti-vibratória Flangeada

33.1160	32	34,13 €
33.1161	40	34,77 €
33.1162	50	36,70 €
33.1163	65	46,54 €
33.1164	80	54,79 €
33.1165	100	65,74 €
33.1166	125	94,64 €
33.1167	150	131,77 €
33.1168	200	191,23 €
33.1169	250	239,11 €
33.1170	300	363,57 €



*Válvula borboleta Wafer
c/disco F/F*

33.1120	50	34,45 €
33.1121	65	41,61 €
33.1122	80	44,77 €
33.1123	100	58,78 €
33.1124	125	84,39 €
33.1125	150	98,86 €
33.1126	200	145,38 €
33.1127	250	229,96 €
33.1128	300	320,21 €



*Flanges Standart PN 10/16 Roscada
DN-Polg-mm*

33.1175	32-1.¼"-42,4	15,50 €
33.1176	40-1.½"-48,3	17,80 €
33.1177	50-2"-60,3	23,65 €
33.1178	65-2.½"-76,2	26,25 €
33.1179	80-3"-88,9	33,15 €
33.1180	100-4"-114,3	35,25 €
33.1181	125-5"-139,7	47,75 €
33.1182	150-6"-168,3	57,45 €

Din 2576



*Válvula borboleta Wafer
c/ Disco AISI316
c/volante redutor*

33.1130	200	312,64 €
33.1131	250	471,06 €
33.1132	300	723,67 €
33.1133	350	1.042,67 €
33.1134	400	1.805,22 €
33.1135	500	2.800,22 €



Nota: Esta tabela pode ser alterada sem aviso prévio, preços sujeitos à taxa de I.v.a. em vigor.

Setúbal, 01 de Janeiro de 2018.

Pág.: 108



Hidrosado, Lda.
 Quinta Varzinha, Lote 25
 2900-721 Setúbal
 Telefone: 265537550
 Fax: 265537551
 Mail: geral@hidrosado.pt
 Site: www.hidrosado.pt

Depósitos diversos

Código	Modelo	Ø mm	Comp. mm	Alt. mm	Tampa mm	Preço
--------	--------	---------	-------------	------------	-------------	-------

Deposito Horizontal

30.2001	DHS - 500	750	1250	830	300	240,00 €
30.2002	DHS - 1000	900	1550	1050	400	423,75 €
30.2003	DHS - 2000	1350	1665	1360	400	610,00 €
30.2004	DHS - 3000	1520	1945	1565	400	768,75 €
30.2005	DHS - 5000	1840	2210	1865	400	1.350,00 €
30.2006	DHS - 500 reforçado	750	1250	830	300	298,75 €
30.2007	DHS - 1000 reforçado	900	1550	1050	400	500,00 €
30.2008	DHS - 2000 reforçado	1350	1665	1360	400	723,75 €
30.2009	DHS - 3000 reforçado	1520	1945	1565	400	941,25 €
30.2010	DHS - 5000 reforçado	1840	2210	1865	400	1.731,25 €



Deposito Horizontal grande capacidade para enterrar

30.2015	DHE - 2000 reforçado	1510	1725	1630	400	723,75 €
30.2016	DHE - 3000 reforçado	1510	2375	1630	400	941,25 €
30.2017	DHE - 5000 reforçado	2320	2020	2460	600	1.731,25 €
30.2018	DHE - 10000 reforçado	2320	3300	2460	600	3.493,75 €



* Capacidades maiores sob-consulta

Deposito Vertical

30.2025	DVA - 500	910	-	910	400	243,75 €
30.2026	DVA - 1000	950	-	1600	400	422,50 €
30.2027	DVA - 2000	1350	-	1950	400	610,00 €
30.2028	DVA - 3500	1300	-	2700	400	770,00 €
30.2029	DVA - 4000	1500	-	2400	400	862,50 €
30.2030	DVA - 500 reforçado	910	-	910	400	297,50 €
30.2031	DVA - 1000 reforçado	950	-	1600	400	498,75 €
30.2032	DVA - 2000 reforçado	1350	-	1950	400	711,25 €
30.2033	DVA - 3500 reforçado	1300	-	2700	400	929,00 €
30.2034	DVA - 4000 reforçado	1500	-	2400	400	1.062,50 €



Deposito Vertical PUFFO

30.2041	DVB - 3000	1700	-	1728	400	748,75 €
30.2042	DVB - 3500	1700	-	1978	400	818,75 €
30.2043	DVB - 4500	1700	-	2478	400	997,50 €
30.2044	DVB - 5000	2068	-	1822	400	1.150,00 €
30.2045	DVB - 3000 reforçado	1700	-	1728	400	931,25 €
30.2046	DVB - 3500 reforçado	1700	-	1978	400	1.062,50 €
30.2047	DVB - 4500 reforçado	1700	-	2478	400	1.247,50 €
30.2048	DVB - 5000 reforçado	2068	-	1822	400	1.487,50 €



* Capacidades maiores sob-consulta

Nota: Esta tabela pode ser alterada sem aviso prévio, preços sujeitos à taxa de I.v.a. em vigor.
 Setúbal, 01 de Janeiro de 2018.



Hidrosado, Lda.
 Quinta Varzinha, Lote 25
 2900-721 Setúbal
 Telefone: 265537550
 Fax: 265537551
 Mail: geral@hidrosado.pt
 Site: www.hidrosado.pt

Depósitos diversos



Fossa Séptica Horizontal Millenium com Pré-Filtro PF 17 Equipamento Homologado - Norma EN 12566-1

Código	Modelo	Hab. Eq.	Ø mm	Comp. mm	Alt. mm	Tampa mm	Preço
30.2051	FHC 2000 M	10	1510	1725	1630	400	906,25 €
30.2052	FHC 3000 M	16	1510	2375	1630	400	1.087,50 €

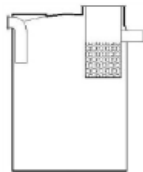

Fossa Séptica Vertical com e sem Pré-Filtro

30.2061	FVC 1000 s/filtro	5	950	-	1600	400	523,75 €
30.2062	FVC 1250 s/filtro	6	1150	-	1600	400	606,25 €
30.2063	FVC 2000 s/filtro	10	1350	-	1950	400	736,25 €
30.2064	FVC 3500 s/filtro	16	1310	-	2700	400	973,75 €
30.2065	FVC 4000 s/filtro	20	1500	-	2400	400	1.061,25 €
30.2066	FVC 1000 c/filtro	5	950	-	1600	400	606,25 €
30.2067	FVC 1250 c/filtro	6	1150	-	1600	400	662,50 €
30.2068	FVC 2000 c/filtro	10	1350	-	1950	400	798,75 €
30.2069	FVC 3500 c/filtro	16	1310	-	2700	400	1.038,25 €
30.2070	FVC 4000 c/filtro	20	1500	-	2400	400	1.123,75 €

* Capacidades maiores sob-consulta

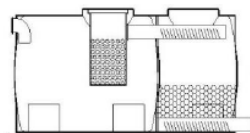
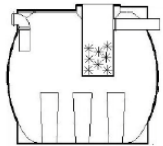

Fossa Séptica Horizontal com e sem Pré-Filtro

30.2075	FHC 1000 s/filtro	5	940	1550	1020	400	518,75 €
30.2077	FHC 2000 s/filtro	10	1350	1665	1405	400	806,25 €
30.2071	FHC 3000 s/filtro	15	1520	1945	1565	400	987,50 €
30.2072	FHC 5000 s/filtro	25	1840	2210	1890	400	1.873,75 €
30.2080	FHC 1000 c/filtro	5	940	1550	1020	400	592,50 €
30.2082	FHC 2000 c/filtro	10	1350	1665	1405	400	868,75 €
30.2085	FHC 3000 c/filtro	15	1520	1945	1565	400	1.056,25 €
30.2086	FHC 5000 c/filtro	25	1840	2210	1890	400	1.988,23 €

* Capacidades maiores sob-consulta

Fossa Séptica Compacta com Biodiscos

30.2090	FCC 1500 c/filtro	6	940	2200	1020	2x400	1.087,50 €
30.2091	FCC 2500 c/filtro	10	1350	2250	1405	2x400	1.537,50 €
30.2092	FCC 5000 c/filtro	15	1520	2916	1565	2x400	2.498,75 €
30.2093	FCC 8000 c/filtro	25	1840	3315	1890	2x400	4.537,50 €
30.2094	FCC 15000 c/filtro	45	2320	4580	2460	2x600	7.378,50 €

* Capacidades maiores sob-consulta

Soluções Ecoprocess Filtro Compacto de Coco

As soluções Ecoprocess™ Filtro Compacto de Coco (com depósitos em fibra ou PEAD) são concebidas para tratar eficazmente os efluentes com características domésticas no âmbito do saneamento de pequenos aglomerados populacionais de 21 a 200 HE. Após pré tratamento na fossa séptica os afluentes são tratados através de um Filtro Compacto de Coco Premier Tech.



Nota: Esta tabela pode ser alterada sem aviso prévio, preços sujeitos à taxa de I.v.a. em vigor.
 Setúbal, 01 de Janeiro de 2018.



Hidrosado, Lda.
 Quinta Varzinha, Lote 25
 2900-721 Setúbal
 Telefone: 265537550
 Fax: 265537551
 Mail: geral@hidrosado.pt
 Site: www.hidrosado.pt

Acessórios para Bombas



Código	Designação	Preço
19,1004	Retentor 12mm + Base (CP45/75- Leo - Jet100)	14,00 €
19,1005	Retentor 15mm mola + Base (CR100)	16,40 €
19,1006	Retentor 18mm mola + Base	27,30 €
19,1007	Retentor 20mm mola + Base	27,30 €
19,1008	Retentor 22mm mola + Base	28,00 €
19,1028	Retentor DAB K28/500	46,30 €
19,1026	Retentor Matra CM 40/550	98,70 €
19,1009	Retentor Matra CM 40/1000	123,00 €
19,1052	Retenror Silen (piscina)	43,00 €
19,1055	Turbina (CAM75/100/150/250 / MB / Leo)	16,46 €
15,2016	Turbina latão (CAM 100)	25,80 €
19,1035	Turbina CR 100	16,46 €
19,1010	Turbina plástico CB 150	23,00 €
19,1056	Turbina latão CB 150	39,50 €
19,1057	Turbina latão CB 200	39,50 €
15,2015	Turbina latão CB 300	46,00 €
19,1059	Turbina (CS 150)	50,50 €
19,1011	Turbina XKS	18,00 €
19,1045	Turbina Silen (piscina)	25,00 €
19,1036	Turbina CP 45 - CM6/1	16,80 €
19,1039	Turbina CP 75 - CM6/4	17,35 €
19,1080	Turbina arrefecimento motor pequena	5,50 €
19,1082	Turbina arrefecimento motor grande	11,00 €
19,1069	Difusor CAM75/100 - Jet	19,00 €
19,1070	Difusor CAB 150/200/ MB	22,00 €
19,1015	Tampa difusora CAB 150/200/ MB	13,65 €
15,1009	Rolamentos 6200 2RS	10,56 €
15,1017	Rolamentos 6201 2RS	11,28 €
15,1001	Rolamentos 6202 2RS	12,00 €
15,1002	Rolamentos 6203 2RS	12,80 €
15,1005	Rolamentos 6204 2RS	14,56 €
15,1004	Rolamentos 6205 2RS	15,92 €
15,1006	Rolamentos 6206 2RS	18,40 €
15,1026	Rolamentos 6208 2RS	23,44 €
15,1019	Rolamentos 6302 2RS	15,60 €
15,1021	Rolamentos 6303 2RS	14,80 €
15,1022	Rolamentos 6304 2RS	16,80 €
15,1023	Rolamentos 6305 2RS	21,04 €
15,1024	Rolamentos 6306 2RS	23,68 €
15,1038	Rolamentos 6308 2RS	29,60 €
19,1087	Caixa ligação eléctrica CAM 100 - Jet	7,21 €
19,1088	Caixa ligação eléctrica CAB 150/200	7,21 €
19,1094	Hidrojector 1.¼" x 1"	42,00 €
19,1014	Ventury CAM 75/100 - Jet	13,50 €

Nota: Esta tabela pode ser alterada sem aviso prévio, preços sujeitos à taxa de I.v.a. em vigor.
 Setúbal, 01 de Janeiro de 2018.

